



**CustomCages.com**

**VISION**  
RACKS & CAGES



**CustomAQUARIUMS.com**



# ABOUT US

## ABOUT QR CODES



[customaquariums.com/home20](http://customaquariums.com/home20)



[customcages.com/home20](http://customcages.com/home20)



[visionproducts.us/home20](http://visionproducts.us/home20)

You will notice QR codes as shown above throughout the catalog. Just download any free QR viewer app for your smartphone or tablet through your app store, snap a picture of the code with your app, and your smart device will instantly whisk you away to the relevant video or informational web page! Since we have so many unique and custom capabilities, it is impossible to adequately explain all of our innovations in a print catalog. The QR codes will turn this catalog into an interactive experience to help you explore all we have to offer to make the ultimate habitat for you and your pets! If you do not have a way to view the QR codes, notice a direct web link is listed near each QR code that will go directly to the relevant topic on our websites.

## OUR STORY

What started as a childhood hobby officially became a corporation in 1998. Our founder began building cages when he was a 19-year-old University of Wisconsin Oshkosh sophomore. The first generation of “Cages By Design” products were born in the basement of his modest college apartment. He sold, built, and shipped all of his hand made products while also attending college full time.

A shell of a website was launched when most people didn’t even know what the internet was. A tiny black and white ad in a trade publication was just the beginning. Through a lot of trial and error and ups and downs, the business gradually gained its footing. Four years later upon graduation, a 3,000 square foot commercial shop was built in Neenah, WI, as well as the first employee hired.

Through years of experimenting, listening to customer’s needs, and countless hours of engineering, CagesByDesign.com became *CustomCages.com*, *CustomAquariums.com* was developed, and eventually they became the premier brands in the industry. Serenity Aquarium and Aviary Services (*SerenityUSA.com*), our sister company, was also a product of this adventure and now has over 1,500 service accounts in 40 states. Our experience with manufacturing the products, taking orders directly from our customers, and offering ongoing servicing gives us a unique perspective in the eyes of the customer, which allows us to identify needs, innovate, and create solutions. Our motto is, “**WE DON’T JUST MAKE PRODUCTS, WE SOLVE PROBLEMS!**”

Through years of customer feedback, all of our core brands (*Hybrid Enclosures*®, *Majestic Enclosures*®, *Suncatcher Enclosures*®, *Lifetime Aquariums*®) were entirely engineered in-house. Not only are all of our various cage brands designed and engineered by us, but innovations like the *Friendly Feeder*®, *H2Overflow*®, *Stealth Box*®, *Seamless Sump*®, *Siphon Stopper*®, and many others were born out of our commitment to “Solve Problems.” To date, we have nearly 30 patents granted and filed, as well as over a dozen trademarks, and the number of our patented products continues to rise!

A relentless commitment to quality, standing behind our products, and constant innovation has allowed our company to flourish to over 80 employees and growing. Although we now have over 50,000 square feet of state of the art equipment, as well as a team of well-trained expert staff, the principles remain the same—every unit is custom fit for your needs and built one at a time by our proud and expert craftsmen.

After all the years of dedication and hard work, we are very proud to present this collection of products to everyone. This catalog is just a preview—many more options, additional information, and video demonstrations are available on our various websites. We also encourage you to explore our social media pages to see what our dedicated customers have to say. We look forward to being a part of making your pet happy and healthy, and we welcome you to the growing family we call our customers and friends!



Like us on Facebook!



[customcages.com/facebook20](http://customcages.com/facebook20)



[visionproducts.us/facebook20](http://visionproducts.us/facebook20)



[customaquariums.com/facebook20](http://customaquariums.com/facebook20)

## CONTENTS

TESTIMONIALS & SHIPPING INFO ..... 3

**CustomAquariums.com**

LIFETIME® AQUARIUMS ..... 4-5

AQUARIUM SPECIALS—RECTANGULAR ..... 6-7

AMPHIBIOUS AQUARIUMS/PALUDARIUMS ..... 8

RIMLESS, HEXAGON, PENTAGON & CUBE AQUARIUMS ..... 9

MAJESTIC® STANDS & CANOPIES ..... 10

NOT ALL STANDS ARE CREATED EQUAL ..... 11

MAJESTIC® CASTER CARTS & STEEL STANDS ..... 12

LIFETIME® STANDS & CANOPIES ..... 13

H2OVERFLOW® & SIPHON STOPPER® ..... 14

H2OVERFLOW® STEALTH BOX® ..... 15

SEAMLESS SUMPS® ..... 16

CHECK OUT THESE VIDEOS TO LEARN MORE ..... 17

**CustomCages.com**

OUR BRANDS ..... 18

SUNCATCHER®

SUNCATCHER® CAGE FEATURES & ACCESSORIES ..... 19

SUNCATCHER® BIRD CAGES & ENCLOSURES ..... 20-21

SUNCATCHER® CAT CAGES & ENCLOSURES ..... 22-23

SUNCATCHER® DOG CAGES & KENNELS ..... 24

MAJESTIC®

MAJESTIC® CAGE FEATURES & ACCESSORIES ..... 25

MAJESTIC® BIRD CAGES & ENCLOSURES ..... 26-27

MAJESTIC® REPTILE CAGES & ENCLOSURES ..... 28-29

HYBRID®

HYBRID® CAGE FEATURES & ACCESSORIES ..... 30

HYBRID® BIRD CAGES & ENCLOSURES ..... 31-32

HYBRID® REPTILE CAGES & TANKS ..... 33-34

**Vision Racks & Cages**

VISION CAGES ..... 35

VISION BREEDING RACKS ..... 36

VISION RODENT BREEDING RACKS ..... 37

RESELLERS & MAINTENANCE SERVICES ..... 38

TESTIMONIALS ..... 39

VIDEO TESTIMONIALS ..... 40

DIY AQUARIUMS/VLOGGER VIDEOS ..... 41

SOLID GOLD AQUATICS VIDEOS ..... 42

VIDEO TESTIMONIALS ..... 43

DIY CAGES/VLOGGER VIDEOS ..... 44-45

FEATURED ACCESSORIES ..... 46-47

BACKGROUNDS ..... BACK COVER



CHECK OUT OUR CHANNELS & SEE OUR PRODUCTS IN ACTION!



[customaquariums.com/youtube20](http://customaquariums.com/youtube20)

[customcages.com/youtube20](http://customcages.com/youtube20)



© 2020 Adam’s Specialty Products, LLC. All Rights Reserved. *CustomAquariums.com*®, *Lifetime Aquariums*®, *Lifetime*®, *Siphon Stopper*®, *Seamless Sump*®, *H2Overflow*®, *H2Overflow*®, *Stealth Box*®, *CustomCages.com*®, *Hybrid*®, *Majestic*® Enclosures, *Suncatcher*® Enclosures, *Friendly Feeder*®, *Vision Racks and Cages*®, and other product and service names are the trademarks or service marks of Adam’s Specialty Products, LLC.

**CustomAquariums.com | (844) 244-8265**

**CustomCages.com | (800) 941-2243**

**VisionProducts.us | (920) 886-1220**



48"H x 120"L x 36"D Salt Water Aquarium –  
Approximately 1,000 Gallons

"I would like to express my sincere gratitude to **Custom Aquariums**. They not only built an awesome tank for me but did it in record time. The sump system is well engineered and allows my corals and fish to thrive.

My entire family spends hours enjoying the tank and it has become a center piece to all of our entertainment and parties at the house.

I 100% recommend this product and cannot be happier with my choice for the tank. Thanks again for a wonderful part of our family's lives!!"

Best,  
Darren H.  
Oklahoma City, OK

[customaquariums.com/testimonials20](http://customaquariums.com/testimonials20)

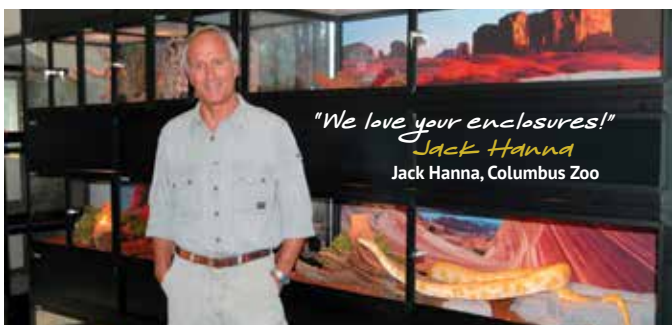

"We love your enclosures!"  
Jack Hanna  
Jack Hanna, Columbus Zoo



## CustomCages.com PARTNERS WITH JACK HANNA TO OUTFIT COLUMBUS ZOO

CustomCages.com partnered with Jack Hanna and the Columbus Zoo to completely renovate their holding room for promotional animals. These are the very same animals you see with Jack on various television shows. "We are very excited to win the approval of such a conservationist and well known figure in the industry," says Adam Keller, president of Custom Cages. "We are very happy and honored to do this for them." The Custom Cages team installed over \$50,000 worth of enclosures and accessories for Jack Hanna at the zoo. The cages hold everything from macaws to snakes to armadillos.

Because of our commitment to quality and our long-standing track record of generosity to humane centers nationwide, we were honored to receive a full, unpaid endorsement from Jack Hanna.

[customcages.com/testimonials20](http://customcages.com/testimonials20)



## RUBY THE TEGU IN HER NEW VISION CAGE MODEL 432

"Ruby LOVES her cage and all the space she has to grow into. She just turned one! Thank you for all of your help!"

—Angela

[visionproducts.us/testimonials20](http://visionproducts.us/testimonials20)



### FREE SHIPPING NATIONWIDE\*

\*Applies to any order with an aquarium over \$3,000 or any Ultimate Majestic® or Hybrid® Package Special. Some exceptions apply for difficult or remote locations. Continental US only.

For all other orders, please visit the respective website or call for a quote as rates vary with individual circumstances.

### LEAD TIMES

Most orders are built to order one at a time which means lead times will vary significantly depending on brand and season. Please visit the respective website to see our latest expected lead time.

All freight orders are well crated and most can be delivered curb side to your door.

## CHECK OUT OUR VIDEO ON DELIVERY & MOVING KITS!



[customaquariums.com/shippingvideo20](http://customaquariums.com/shippingvideo20)



[customaquariums.com/shipping20](http://customaquariums.com/shipping20)



[customcages.com/shipping20](http://customcages.com/shipping20)



## NOT ALL AQUARIUMS ARE CREATED EQUAL.

Finally... a build-to-order aquarium system that allows you to choose what configuration you want based on your specific needs. And with our *\*free delivery* and *refundable moving kits*, even the largest aquariums can be easy to install in your home or office. There are many advantages of our patented design to consider when comparing to our competition.

**WE ENCOURAGE YOU TO WATCH OUR VIDEO TO SEE THE DIFFERENCE!**

## ADVANCED ENGINEERING & FABRICATION

**NOT ALL AQUARIUMS ARE MANUFACTURED WITH OUR STANDARDS AND ATTENTION TO DETAIL.**

Our aquariums are made with state of the art CNC equipment and precision manufacturing techniques making them stronger, safer, and more visually appealing. Check out our video on YouTube to learn more!

Scan the QR code below or visit [customaquariums.com/advancedengineering20](http://customaquariums.com/advancedengineering20) to learn more!



YouTube

[customaquariums.com/advancedengineering20](http://customaquariums.com/advancedengineering20)

- Built-to-order for practically any size up to 1,600 gallons
- Choose from multiple material thicknesses, clarity, and tempering options
- Patented marine grade anodized aluminum frame with unmatched integrity
- Removable reinforced aluminum center supports—no cracking, easy aquascaping!
- ALL edges beveled and polished for strength and cosmetics—even edges you don't see! Most other manufacturers take shortcuts where we don't!
- More silicone and better mechanical bonds—due to beveling on the seams—than other manufacturers!
- Custom holes for overflows/sumps (2 sided automated glass drill for "cleaner" holes!)
- Commercial quality, professional look and feel
- FREE delivery Nationwide\* (see p. 3)
- Refundable moving kits make installation easy!
- Higher quality, more durable, and less expensive than acrylic
- Engineered and Built to Last a **LIFETIME!**
- Visit our online configurator to build and get an instant price for your dream enclosure!



[customaquariums.com/configurator20](http://customaquariums.com/configurator20)

**ONLINE CUSTOM CONFIGURATOR!  
BUILD YOUR COMPLETE DREAM TANK ONLINE  
& GET INSTANT PRICING!**

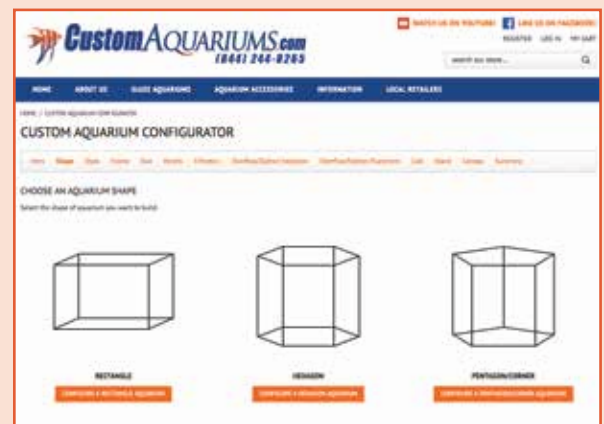

Aluminum frame with removable aluminum center supports

## ALUMINUM FRAME SYSTEM

Our proprietary patented aluminum frame system not only adds strength and durability, but allows us to custom build to order virtually any size and still maintain commercial grade strength and a professional look. Most other custom glass aquariums out there are made with a euro-frame design, which basically means it is pieced together with large chunks of reinforcement glass and lots of unsightly silicone. If you are interested in a "euro" style" custom aquarium, be sure to examine close up pictures of the frame. The aesthetics leave something to be desired, and because of all the additional glass involved, they are quite a bit heavier. Euro-braces also make standard maintenance and aqua-scaping more difficult due to the amount of space that euro-braces often extend into the tank.

SCAN QR CODE OR VISIT THE LINK TO LEARN MORE ABOUT OUR FRAME SYSTEM!

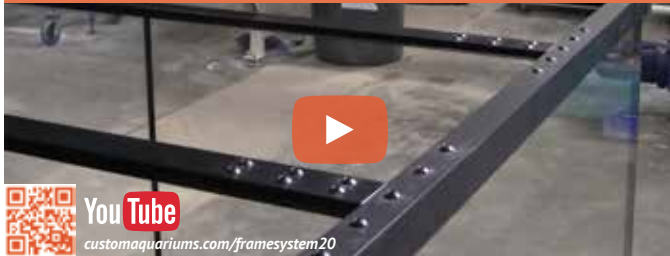

## CUSTOM AQUARIUMS MATERIAL OPTIONS

Available materials: 1/4", 3/8", 1/2", 3/4" thicknesses, tempered and non-tempered, regular clarity and ultra-clear (low iron) glass. Many fabrication capabilities and options. Scan the code or visit [customaquariums.com/materials20](http://customaquariums.com/materials20) to find out more!

## REMOVABLE CENTER BRACES

Our center braces are not only much stronger than plastic center braces (the most vulnerable part of most aquariums), but they are removable! Remove with a common wrench, aquascape, replace! It's that easy and will be as strong as the day you bought it!



## PLASTIC FRAME CENTER BRACE FAILURE

We get calls CONSTANTLY from people who have old established corals and they are in an emergency situation because their plastic center piece broke...**CAN'T HAPPEN WITH OUR DESIGN!**

## THIS IS WHY WE BELIEVE OUR ALUMINUM FRAMING IS THE BEST!

This is from a lovely lady who called after her center cross brace broke. "I sent a request to customer service asking about my tank that had just developed a crack in the top brace. Seeing as it was a holiday, I did not expect to hear from anyone on the same day, but to my surprise I had



a response within the hour. While the answer to my question was not what I was hoping to hear, I was very pleased with the quick response and the honest advice given. I will be sure to visit **Custom Aquariums** in the future for all of my aquatic needs!! I am very satisfied with the service that I received!"

—Jessica W.

## ULTRA-CLEAR GLASS – 3/8"–3/4" TEMPERED OR NON-TEMPERED

Ultra-clear glass has about the same strength as regular clarity of the same thickness. The difference is the ultra-clear has a lower iron content that gives it an exceptionally clear look. This option is a very nice feature but does cost a bit more money. Our system gives you the flexibility to upgrade as many or few panels as you desire depending on the placement, configuration, and budget of your tank.



We edge and polish **ALL** edges of the aquarium, **EVEN THE EDGES YOU CAN'T SEE!** This adds significant strength by removing micro fractures—an extra step most manufacturers do not do!



## GET A GOOD GRIP WITH OUR REFUNDABLE MOVING KITS!

[customaquariums.com/movingkits20](http://customaquariums.com/movingkits20)

When you order a refundable moving kit, we will include an appropriate number of suction cups to help facilitate moving your aquarium from the crate on your curb to its destination. We will include a return box and a pre-printed return label. As soon as you are done using them, just pack up, return, and we will refund the deposit less return shipping and rental fees.



## ENAMEL BACKGROUNDS

A painted on permanent enamel background is a great way to hide all of the unsightly cords and hoses behind your tank. No background coming loose or having to mess with tape or adhesives to keep the background on.

**SEMI PERMANENT MOUNTED IMAGE BACKGROUNDS AVAILABLE! SEE BACK COVER FOR DETAILS.**

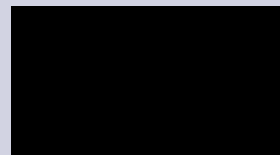

Mystic Black Enamel



Lily Pad

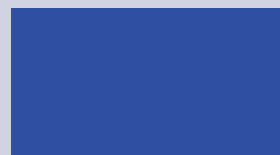

Deep Sea Blue Enamel



Sunken Treasure

# AQUARIUM SPECIALS – RECTANGULAR

[customaquariums.com/rectanglespecials20](http://customaquariums.com/rectanglespecials20)



AQUARIUM SPECIALS – RECTANGULAR

Our aquarium packages (see details online) are specifically designed by our full time service experts to have the proper size and flow ratings depending on the size of the aquarium. Plenty of additional circulation, aeration, flow, skimming capacity, and surface area of bio filtration are accounted for in these packages, with redundancy and safety measures already factored in. Of course, upgrades can be applied for ultra-sensitive setups. An "ultimate package" will provide a truly professional commercial grade setup. Additional items such as skimmers and wave makers can be added that work great for salt water and reef. **THE 300 GALLON TANK SHOWN BELOW IS A THRIVING CORAL TANK AT OUR HEADQUARTERS RUNNING ON OUR H2OVERFLOW® & SEAMLESS SUMP® SYSTEM.** All packages can be further customized. Give us a call, our experts will be happy to help you configure a perfectly optimized **LIFETIME®** Aquarium custom tailored for your needs!



**300 GALLON\* – 30”H x 96”L x 24”D**



**75 GALLON\* – 24”H x 36”L x 18”D**  
 PICTURED ABOVE: Classic Trim, Country Raised Panels, Autumn Cherry Stain on Oak Wood



**90 GALLON\* – 30”H x 36”L x 18”D**  
 PICTURED ABOVE: Classic Trim, Elite Raised Panels, Natural Oak Stain on Oak Wood



**100 GALLON\* – 24”H x 48”L x 18”D**  
 PICTURED ABOVE: Contemporary Trim, Standard Flat Panels, White Paint on Oak Wood

**MANY MORE DISCOUNTED “SPECIALS” ONLINE!**

\*Please visit [CustomAquariums.com](http://CustomAquariums.com) to learn more about our packages and our gallon/model ratings.

# AQUARIUM SPECIALS – RECTANGULAR



**110 GALLON\* – 30”H x 48”L x 18”D**  
 PICTURED ABOVE: Classic Trim, Standard Flat Panels, Colonial Oak Stain on Oak Wood



**180 GALLON\* – 30”H x 72”L x 18”D**  
 PICTURED ABOVE: Classic Trim, Standard Flat Panels, Autumn Cherry Stain on Oak Wood



**240 GALLON\* – 30”H x 72”L x 24”D**  
 PICTURED ABOVE: Classic Trim, Country Raised Panels, Dark Walnut Stain on Oak Wood



[customaquariums.com/slidingdoors20](http://customaquariums.com/slidingdoors20)

## ALSO WORK GREAT FOR REPTILES!



### REMOVABLE SLIDING DOORS AVAILABLE ON TOP OF ANY RECTANGULAR TANK:

- Many material options available!
  - For ventilation and cricket proofing
  - Keyed lock included making them escape proof!
- Please call **(844) 244-8265** for pricing



**CUSTOM AQUARIUMS – SAFE, STRONG & DEPENDABLE**  
 There are many factors to consider when choosing a large custom aquarium...



**CUSTOM AQUARIUMS OVERVIEW VIDEO – CAPABILITIES & FEATURES**  
**CustomAquariums.com** is the factory direct outlet store for our proprietary Lifetime® Aquarium system. Lifetime® aquariums have a range of options including glass thickness, tempering, clarity, as well as many shapes and sizes. **THIS IS A MUST WATCH VIDEO TO SEE WHAT CUSTOM AQUARIUMS IS ALL ABOUT!**



Now any of our standard aquariums can be made as amphibious aquariums with sliding front, back, or side doors for more convenient access to your amphibious animal! This is also a benefit as it eliminates the hassle of removing the top of the aquarium whenever you need to reach into the enclosure. The bottom half holds water, the top half is great for viewing and giving your plants and animals dry space with easy access!

## LAND & SEA CUSTOMIZATION

Our amphibious aquariums hold water on the bottom and have sliding doors on the top for easy access. Glass dividers or clever aquascaping can create as much or as little “land” as you desire. These aquariums make excellent habitats for a multitude of reptile and amphibian species such as *turtles, caimans, snakes, monitors, chameleons*, and many more! When incorporated with an H2Overflow® and Seamless Sump®, well stocked turtle tanks stay clear for many weeks, and don't smell!!! The amphibious aquariums don't necessarily have to hold water—for example, they make for great *bearded dragon, snake*, and other reptile enclosures simply because of the easy access and ability to put ample substrate without the risk of spilling out of the tank. Amphibious aquariums are great as well for terrarium setups with live plants and multi species as well as aquaponics!

### REMOVABLE SLIDING DOORS



- AMPHIBIOUS AQUARIUM FEATURES:**
- Your choice of glass front, side, or back doors
  - Doors remove for easy cleaning
  - Seamless Sump® complete filtration available with H2Overflows® and Siphon Stopper® outputs—even turtle tanks will not smell and will stay clear for weeks without cleaning!
  - Keyed lock for security
  - Professional marine grade aluminum framework with minimal door overlap gaps
  - Printed and mounted backgrounds available—including land/water themes—see back cover
  - Multiple options for water depth
  - Custom glass dividers available for land/sea concepts
  - Lids can be made of glass or partially ventilated with cricket proof perforated aluminum
  - Sliding doors on top of the tank also available (see p. 7 for pictures)
  - Custom wood materials and finishes available for stands and canopies (see p. 10)





[customaquariums.com/paultestimonat20](https://www.youtube.com/watch?v=paultestimonat20)

### PAUL DEMAS' PALUDARIUM

Paul Demas designs and installs beautiful vivarium and paludarium displays. He chooses *Custom Aquariums* enclosures for the overall quality and the ease of use of the filter system.

The enclosure in this video is a custom amphibious aquarium with the overall dimensions of 36" long x 36" tall x 24" wide. Paul's aquarium has side door placement for uninterrupted viewing. The water section is 12" deep and has a volume of 45 gallons. The display is filtered by a *Seamless Sump®* filter system. The stand and canopy are oak with custom panel upgrades.



**OVERALL INTERIOR VOLUME: 385 GALLONS**  
**WATER VOLUME: 110 GALLONS –**  
**48" H x 72" L x 24" D – 10" H MAJESTIC® CANOPY**  
**30" H MAJESTIC® STAND**

PICTURED ABOVE: Classic Trim, Classic Flat Panels, Clear Coat on Rustic Hickory

\*Please visit [CustomAquariums.com](https://www.CustomAquariums.com) to learn more about our packages and our gallon/model ratings.

# RIMLESS, HEXAGON, PENTAGON & CUBE AQUARIUMS

## RIMLESS AQUARIUMS

Most of our standard glass aquariums of any shape can also be made as rimless glass aquariums. Works great for corals, planted, stingrays, turtles/tortoises, and more! Our classy polished beveled edge and superior craftsmanship make our rimless tanks the premier rimless brand on the market today. When required, our **MAJESTIC®** stands come with center supports so even the largest rimless glass aquarium is well supported. We also have our own unique, innovative center concealment column you will not find anywhere else to assist in adding plumbing such as our H2Overflow® and Siphon Stoppers® to make filtration easy for island tanks.



VISIT [CustomAquariums.com](http://CustomAquariums.com)  
TO SEE OUR RIMLESS TANKS IN ACTION!

[customaquariums.com/rimless20](http://customaquariums.com/rimless20)

## 180 GALLON\* PENTAGON – 30”H x 38”L x 38”D

Pictured in Contemporary finish



[customaquariums.com/pentagonspecials20](http://customaquariums.com/pentagonspecials20)



\*Pictured diagram is an overhead view of the 180 gallon Pentagon Corner aquarium

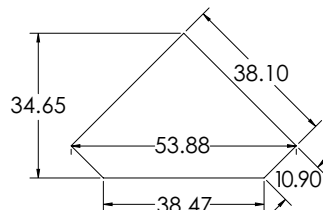

**MANY MORE SIZES AVAILABLE!**

## 475 GALLON\* HEXAGON – 30”H x 72”DIAMETER



[customaquariums.com/hexagonspecials20](http://customaquariums.com/hexagonspecials20)

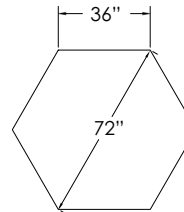

\*Pictured diagram is an overhead view of our 475 gallon Hexagon aquarium

## 120 GALLON\* CUBE – 30”H x 30”L x 30”D

Pictured in Cambridge Cherry Finish



[customaquariums.com/cubspecials20](http://customaquariums.com/cubspecials20)

\*Please visit [CustomAquariums.com](http://CustomAquariums.com) to learn more about our packages and our gallon/model ratings.

# MAJESTIC® STANDS & CANOPIES

customaquariums.com/majestic20



The most important part of any aquarium setup that will determine the life of your aquarium is the quality of the stand that supports it over time. Our stands and canopies are built to last with unmatched quality and materials—no shortcuts taken—which is why we guarantee our aquariums that sit on our stands for **LIFE!** See our **LIFETIME®** warranty for details.

## CLASSIC STANDARD STYLES CONTEMPORARY



### STANDARD FINISHES



\*Due to printing variations, colors may not be accurate. Sample kits available upon request.

### MAJESTIC® STANDS & CANOPIES KEY FEATURES:

- Solid Oak or hardwood frame provides much needed strength and integrity
- Many standard stain colors to suit your taste and décor
- Classic and Contemporary standard style choices
- 3/4" plywood top and back for additional strength—**NO PARTICLE BOARD!**
- Standard holes cut/drilled for cord and tube management
- Double layer top coat for long time moisture resistance
- Unlimited custom woods, styles, and finishes available—we are custom experts!

SCAN QR CODE OR VISIT THE LINK TO LEARN ABOUT OUR MAJESTIC® AQUARIUM CANOPIES & STANDS!



### RAISED PANELS

Each Majestic® stand has the option to include raised panels for your doors. We are sure to have a style that works for you. With standard, classic, country, and elite options, you are able to choose the perfect finishing touch for your stand. There is no doubt that our craftsmanship will show!



Standard—Flat Panel  
Image Shown is Natural Oak Stain on Oak Wood

Classic—Flat Panel  
Image Shown is Natural Oak Stain on Oak Wood

Country—Raised Panel  
Image Shown is Colonial Oak Stain on Rustic Hickory Wood

Elite—Raised Panel  
Image Shown is Clear Finish on Black Walnut Wood

### FULLY CUSTOMIZABLE AQUARIUM STANDS

Custom wood and finish options built to suit! Hickory, Black Walnut, Cherry, Maple, and many more wood options available upon request. Color matching, antiquing, creative molding and raised panel profiles, shapes, and trims also can be made to order. **LET US WORK WITH YOU TO BUILD A UNIQUE HEIRLOOM QUALITY FURNITURE PIECE OF YOUR DREAMS!**



Black Walnut



Natural Hickory

Natural wood finish pictured on Black Walnut and Natural Hickory wood, custom raised panels



# NOT ALL STANDS ARE CREATED EQUAL



## THEIRS:

- Weak softwood frame
- Inadequate spacing of uprights
- **NO BACK AT ALL** providing virtually no structural support
- Large space between wall and stand due to sump being accessed from the rear
- Cluttered back due to poor access for large sump
- Poor deflection properties
- Sags and warps over time
- Non precise squareness/leveling resulting in out of square stresses on the tank/silicone

## OUR MAJESTIC® STANDS:

- All Hardwood Frame (softwood will NOT hold up)
- Solid 3/4" plywood on the top and back
- No clutter behind the tank when used with **SEAMLESS SUMP®** system

## ENGINEERING OF OUR AQUARIUM STANDS

It is not enough for the design of an aquarium stand to hold the weight of the aquarium from collapsing... if you want your aquarium to last a **LIFETIME**, the aquarium stand has to be engineered to have virtually no structural deflection over long periods of time (meaning virtually no sagging under the heavy weight of the full aquarium). Softwood will not do it, particle board will not do it, and certainly stands without any back at all WILL NOT DO IT. The stand will sag, the aquarium will bow at insufficiently supported areas, and over a long period of time the stress this sagging causes on the silicone of the tank will create a leak. With all the time, energy, money, and pride you have into your beautiful aquarium setup—the worst place to skimp on quality to save a little money is the stand, without question. Not only will you lose all the value of your stand, but the aquarium, all the livestock, cleanup cost, and a LOT of stress. Water damage from aquarium failures can often lead to catastrophic damage to a home in the tens of thousands of dollars or more. Imagine replacing all of your carpet, drywall, and sub-flooring in all the surrounding areas of your aquarium and even the levels below it, not to mention fees for emergency cleanup crews—these things NEVER happen at a convenient time. It's not worth it to save a few dollars. We know this best—we get calls every day from customers who need emergency replacements due to leaks from inadequate stands, only second to center bracket failures. You may find much less expensive stands on the market, but there are very real and serious drawbacks to consider. **WE SIMPLY WILL NOT MAKE OR SELL A POORLY ENGINEERED STAND IN ORDER TO COMPETE ON PRICE.**

## OTHER BRAND MASS PRODUCED STANDS—INFERIOR CONSTRUCTION, DIFFICULT ACCESS

Many of the other stands you see on market are made out of inexpensive softwood and particle board and don't even have ANY back material, much less the sturdy 3/4" plywood that we use. Part of the reason they do this is to save money, part of the reason is so you can get your sump in through the back of the stand because they do not fit through the front door. Our **SEAMLESS SUMP®** system was carefully designed to be easily fit through the front door of our **MAJESTIC®** stands and are modular, so you can add as many components as you want for a plug and play system. Because of this we are able to have solid 3/4" backs to properly support your tank for a **LIFETIME... THEIRS MAY BE A LITTLE CHEAPER, BUT IS IT WORTH JEOPARDIZING EVERYTHING OVER? THE DIFFERENCES ARE SUBSTANTIAL AND CRITICAL.**

## HOMEMADE SOFTWOOD CONSTRUCTION STANDS

Many people will decide to either build their own stand or have their general contractor build it out of 2X material for various reasons. Sometimes to save money, sometimes because they enjoy the DIY aspect of the build. Both are understandable reasons, and for smaller aquariums this may be sufficient, but for larger tanks there are some serious implications to consider. For taller tanks, meaning 24" and above, softwood material is rarely if ever adequate to support the tanks for long periods of time. Softwood and 2X material are inherently unstable—meaning it warps and twists over time which provides torsional and uneven stress loads on the silicone joints of your tank. People also generally underestimate the strength required to hold the tank and underestimate how much a beefy looking 2 x 6" or 2 x 8" will sag over a long span with a lot of weight on it.



This stand made by a general contractor for a very large and tall aquarium resulted in a failure from the stand warping. It "looks" strong but was inadequate.

We often get photos from customers who are ordering a new tank because their tank failed because their homemade stand didn't support it. They are completely surprised because visually they thought it looked very sturdy... however, when we examine the photos, the designs do not have nearly enough upright supports, and the materials in general are softwood materials that just don't stand the test of time a very heavy aquarium requires. When you go back and look at the stand and ask "do you think that stand could support a car on its end, and, not only support it, but never ever twist, bow, or move AT ALL over years and years?" They say "no"... but in reality, that is the kind of weight the stands on these large tanks need to support. This type of construction just does not do it... and even with hardwood and steel stands, the engineering has to be better than an educated guess in order to last a **LIFETIME.**



Our custom engineered caster carts are one of the best investments you can make for your overall aquarium setup as your entire investment in livestock may depend on it at some point in the future. Our carts are rated to hold extremely large amounts of static weight distributed over many caster support points (each caster is rated up to 300lbs). The carts are intended to be permanently mounted to the bottom of your stand even when your aquarium is full, which not only makes initial install of your tank and stand much easier, you also never again have to worry about starting over on your dream tank just because you have to move it! Just drain your tank about 2/3 of the way down (like you are doing a water change), move your tank, and refill! Avoid painful losses of livestock and setup down the road! **NOTICE:** Carts are meant to hold large amounts of static weight over long periods of time—they are not meant to be moved with an aquarium full of water on top of them. Make sure the full weight of your aquarium, stand, and aquascaping do not exceed the Max Weight Rating of the cart.



## MAJESTIC® CASTER CART KEY FEATURES:

- Makes initial installation easier getting into your home/business and positioned in place.
- Makes aquascaping easier as you can aquascope the tank a few feet from the back wall and move in place when done.
- Makes moving at a later date easier. If ever in the future you have to replace your carpet/flooring or clean behind the tank, no problem! Without a cart you would usually have to completely decommission your tank and start over, creating a tragic loss of livestock and a lot of work.
- Makes occasional maintenance of plumbing and wiring behind your tank much easier
- Sometimes people move their tank to a new location just to change things up—no problem!

SCAN QR CODE OR VISIT THE LINK TO LEARN MORE ABOUT OUR MAJESTIC® CASTER CARTS!



## STEEL STAND CONSTRUCTION

customaquariums.com/steelstands20



Some aquariums over a given height will require a welded steel stand because of the extreme weights and pressure tall tanks create per square foot of footprint the aquarium consumes. These extremely heavy tanks require even more attention to detail for engineering because of the extreme weights, and because they inherently hold much more water which can create that much more damage during a failure. Often times when people order a stand, they will compare us to a steel stand that may be made by a friend, or a local welding shop, or another aquarium stand provider who has not taken the time to actually engineer the range of scenarios that custom aquariums can present. The build and construction are simply educated guesses and are usually grossly under engineered for these applications. Most places that aren't used to building stands for aquariums do not have a full appreciation for just how much weight they need to support, sometimes in the many thousands of pounds, and the fact they need virtually no deflection or sagging over long periods of time—it's not enough to keep the stand from collapsing, it needs virtually NO DEFLECTION or else the sagging of the aquarium can lead to stress on the silicone joints and eventually fail. With aquariums, just a small failure, is a complete failure. It only takes one point in the joint to have dramatic consequences.

## OUR STEEL STANDS

Our steel stands have extremely thick tubular construction, thicker and larger diameter as the tank it supports get taller and heavier. No guesswork, we have done the engineering with professional engineers not only on the gauge and diameter required for the steel itself, but the proper spacing for the uprights over the vast ranges of our sizes offered. Our stands are **SOLID** and the quality of our welds are meticulous. Most of the time when we are presented another bid from a customer to compare, we know it isn't engineered properly because the market rate of steel required to build a proper stand is more than what they are charging for the entire stand. Most of the cost of a welded stand is in the cost of the steel itself... so if there is a bid for a dramatically less expensive stand, that almost always means they are using dramatically less steel. It's either thinner, or there are not enough upright supports, or both. The customer is under the illusion they are well covered because the construction is welded steel, but there is a big difference between a properly engineered stand with

adequate thickness and spacing of steel, and an under engineered stand with thin tubes and improper quantity of upright supports. Thin steel can and will warp and buckle under pressure... it is a very risky scenario. It is very easy to present an inexpensive price by using thin steel, however we simply will not make or sell a stand that is not properly engineered to support our tanks simply to compete on price. After all, when our aquariums are purchased with our stands, we warranty them for a **LIFETIME!**



Optional plywood bottom

### OURS

Thick 3/4" plywood top, painted for aesthetics and protection

#### LIFETIME® STAND WARRANTY

We fully appreciate the importance of the quality of an aquarium stand, and we back any tank sold with our **MAJESTIC®** stands or steel stands with a **LIFETIME®** limited warranty. If our stands are not used, we are unable to back a warranty as we can't verify the tank is going to be on a properly engineered stand—chances are it will not be!

Thick tubular steel with clean, strong, professional welds.



### THEIRS

Under-engineered stand, raw & thin plywood top, thin steel



**LIFETIME®** Aquarium Stands and Canopies are available for most aquarium sizes (rectangle only). Online pricing and configurator are now available! With multiple patents, this is the only aquarium stand and canopy system of its kind. Maximum functionality and durability at the most reasonable price point compared to any other system on the market in the world today. If wooden style stands and canopies are preferred, please see our wood framed **MAJESTIC® STANDS & CANOPIES** (see p. 10)– hand crafted in the USA!

### 300 GALLON\* LIFETIME® STAND & CANOPY IN PRESTIGE MAPLE FINISH



**LIFETIME®** frames are all black anodized aluminum. The doors, side, and back panels are available in the options shown below.

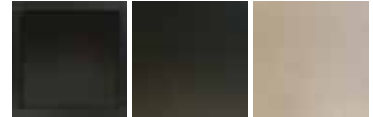

Black Aluminum    Black Granite    Natural Granite



Cambridge Cherry    English Oak    Golden Oak

\*Due to printing variations, colors may not be accurate. Sample kits available upon request.

### DOORS EASILY REMOVE FOR EASY CLEANING!

Vertical permanent supports approximately every 24–30" on longer stands



#### LIFETIME® STANDS & CANOPIES KEY FEATURES:

- Marine Grade Anodized Aluminum Frame—will never rust, chip, or corrode
- Easy Assembly in MINUTES
- Breaks down for easy shipping and storage (even very large units can ship FedEx inexpensively, can be transported with ease, fit through doorways, around corners, up staircases, etc.)
- Removable doors make servicing your sump and aquarium very easy
- Available in a multitude of colors and wood grain patterns
- Panels are a durable, smooth, washable surface (similar to a kitchen counter top). Painted aluminum also available.
- Engineered to handle extreme loads with minimal deflection (ensures the integrity of your aquarium prolonging its life span).
- Available for all of our aquarium sizes, even some of our largest tanks!

#### STACKABLE LIFETIME® WALL UNITS

Let us help custom design your dream facility! Our **LIFETIME®** aluminum frame system can be used as an extremely functional multi-level racking display from small fish rooms to entire pet stores, humane centers, and research facilities. When used in conjunction with our amphibious tanks, the doors are easily removable and interchangeable (glass, wire, acrylic, etc.) allowing you to use different doors as your livestock needs change. This system may be used for fish, birds, reptiles, and many other small animals!

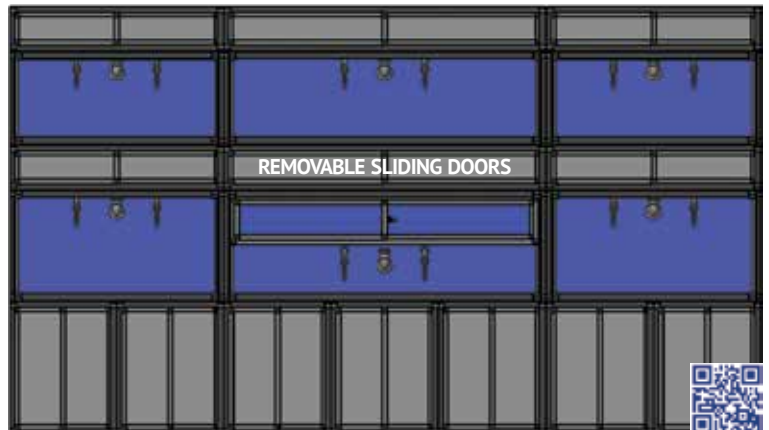

# H2OVERFLOW® & SIPHON STOPPER®



The patented H2Overflow® is an elegant, quiet, efficient way to get water from your aquarium to your sump tub, maintaining your aquarium water overflow. It works great with the Seamless Sump® system (or most other sump systems) and creates an out of sight minimal footprint.

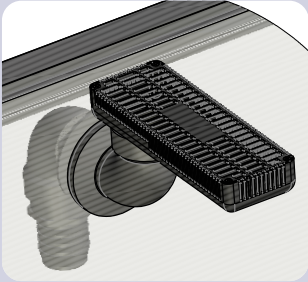

## H2OVERFLOW® KEY FEATURES:

- Works great with the Seamless Sump® system!
- Maximize skimming and aeration capacity with a minimal footprint!
- High capacity overflow volume with very little noise—up to 1200GPH per overflow!
- Easily accommodate higher capacity with additional overflows
- Never see a water line in your aquarium—evaporation takes place in your sump system
- Installs out of your line of sight—you won't even see it at normal viewing height!
- Displaces a fraction of the water as compared to other overflow systems and has more inches of skimming!

SCAN CODE TO LEARN MORE ABOUT OUR H2OVERFLOW®!



- Molded design provides an easy to clean professional appearance
- Can be installed in multiple positions to manipulate water circulation
- Can be mounted out of the way of your reef lights to prevent shadowing
- Easy installation, all that is needed is one hole drilled for a 1½" bulkhead
- No reliance on silicone boxes or holes in the floor of your aquarium
- Order the aquarium from us and we can drill holes for your overflow and returns for you!
- Hole drilling kits available for easy installation on existing aquariums
- Large skimming area minimizes risk of clogging/flooding compared to other overflow screens
- Tapered screen design increases skimming rate automatically as flow rate increases

# SIPHON STOPPER®

Say Goodbye to Failure Prone Check Valves™

The patented Siphon Stopper® is a great way to minimize risk of a back siphon into your sump and at the same time gives you great flexibility to manipulate the water flow of your tank without introducing excessive evaporation. **NO MORE RELIANCE ON FAILURE PRONE CHECK VALVES!**

## SIPHON STOPPER® KEY FEATURES:

- Patented air intake cap automatically breaks a back siphon should the water flow stop
- Minimizes flood risk and volume of back siphon during a power outage or pump failure
- Works great with the Seamless Sump® system!
- Does not rely on check valves with failure prone gaskets or springs
- Loc-Line knuckle allows many output positions and nozzle options
- Siphon Stopper® cap allows surface circulation and aeration
- Siphon stopping cap is above water line, yet below the lids to minimize evaporation
- Can be manipulated in multiple positions to easily control water circulation
- Easy installation, all that is needed is one hole drilled for a 1/2" or 3/4" bulkhead
- Order the aquarium from us and we can drill holes for your overflow and returns for you!
- Hole drilling kits available for easy DIY installation on existing aquariums
- Fixed drilled position reduces the probability of human error
- Installs out of your line of sight, very little visual impact on the look of your aquascape
- Clean, professional look—no "sloppy tank" syndrome

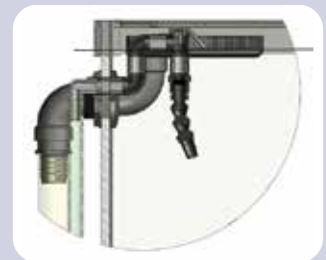

SEE THE SIPHON STOPPER® IN ACTION!



customaquariums.com/siphonstopper20



## STEALTH BOX® SILENT. VERSATILE. DEPENDABLE.



### H2OVERFLOW® STEALTH BOX® KEY FEATURES:

- Allows single, double, or triple H2Overflows® to seamlessly integrate with a multitude of output options for up to 3600GPH! (Single—1200GPH, Double—2400GPH, Triple—3600GPH)
- Many internal plumbing configuration options makes it the most **SILENT** and **VERSATILE** external overflow on the market!
- Top of the Stealth Box® sits evenly with the top of the frame, not the bottom of the frame, meaning you can seamlessly control your water line to be below the lids, yet above the frame of your tank. **NO MORE ANNOYING WATER LINE!**
- One piece molded solution. The box itself as well as the slip fittings on the bottom are made from one piece molded PVC. That means no welds that can be vulnerable to cracking and leaking.
  - Made from black PVC—not abs or polycarbonate, meaning it will create a stronger bond with off the shelf PVC fittings.
- The Stealth Box® comes with 4 molded in 1½” slip fittings, 3 @ ¾” slip fittings, and 3 @ ½” slip fittings on the bottom inside and bottom outside of the box. Most versatile solution on the planet—let your imagination run wild with possibilities!
- Comes standard with 2 @ 1½” fittings in the center open and ready to use. Remaining fittings have pilot hole dimples ready to drill for whatever DIY configuration you decide.
- Internal plumbing kits and ball valves available to aid in your various optimization goals.
- Can be used as a complete gravity fed filtration solution—no external sump needed! As effective as a canister filter with far less risk of leaks and far easier maintenance! See [CustomAquariums.com](http://CustomAquariums.com) for details!

SCAN CODE TO LEARN MORE ABOUT OUR H2OVERFLOW® STEALTH BOX®!



SINGLE H2OVERFLOW® 1200 GPH

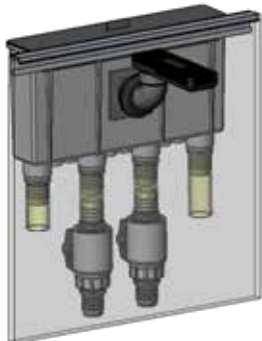

DOUBLE H2OVERFLOW® 2400 GPH

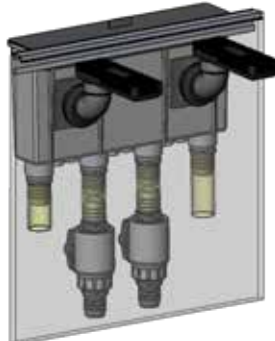

TRIPLE H2OVERFLOW® 3600 GPH

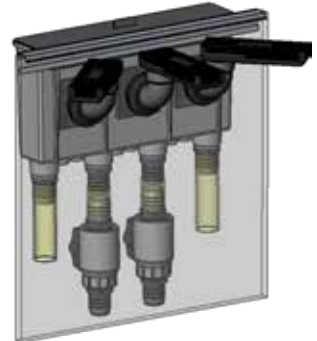

### STEALTH BOX® COMPONENTS

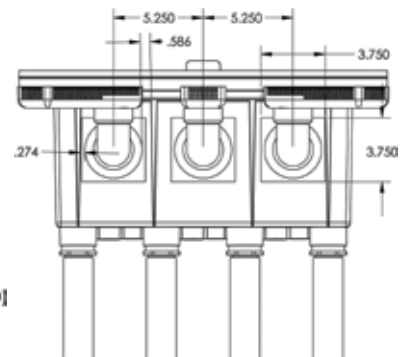
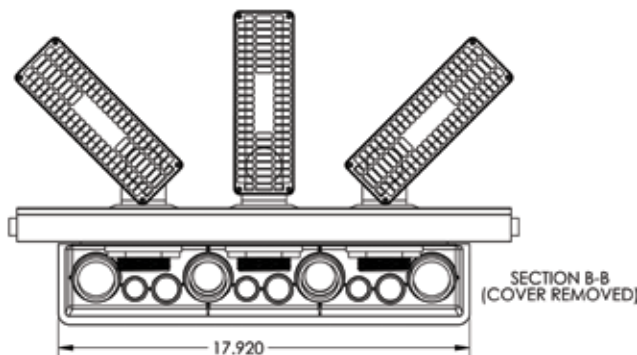
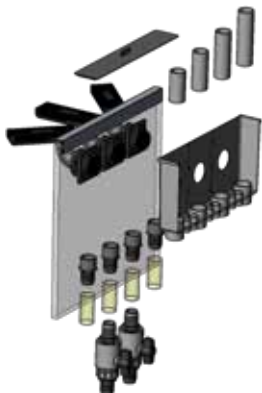

# SEAMLESS SUMPS®

SEAMLESS SUMPS®

The World's Only  
**SEAMLESS SUMP®**



SEAMLESS SUMP®  
BAFFLE TUB



SEAMLESS SUMP®  
MINI RESERVOIR TUB



SEAMLESS SUMP®  
RESERVOIR TUB

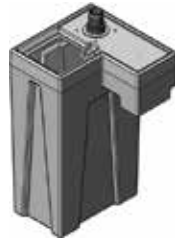

SEAMLESS SUMP® SINGLE  
FILTER SOCK TUB

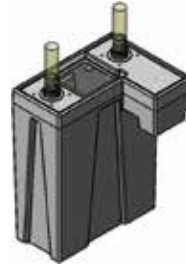

SEAMLESS SUMP® DOUBLE  
FILTER SOCK TUB



SEAMLESS SUMP® JUMBO  
4-SOCK AQUARIUM FILTER/  
PROTEIN SKIMMER TUB

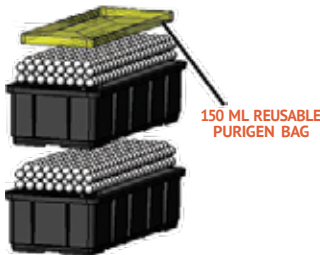

150 ML REUSABLE  
PURIGEN BAG

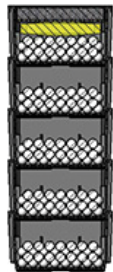

4-SOCK TUB  
WORKS GREAT FOR  
SUBMERSIBLE SKIMMER

SCAN CODE TO LEARN MORE ABOUT OUR SEAMLESS SUMPS®!



customaquariums.com/seamlessump20

## EVAPORATION CONFIGURATION

### CONNECT RESERVOIR LOW

The water in the reservoir tub will equalize with the right half of the baffle tub/pump area and behave as an extension of the evaporation area of the baffle tank. This also adds water volume to dilute harmful nitrates as well as delays the time you need to worry about the pumps running out of water due to evaporation. The more water volume you can add to your overall system, the more significantly you increase the amount of time that can lapse between water changes. Additional water volume also makes it easier to control your salt-to-water ratios.

■ Minimum Water Level ■ Evaporation Capacity ■ Back Siphon/Overflow Capacity with Pumps Off

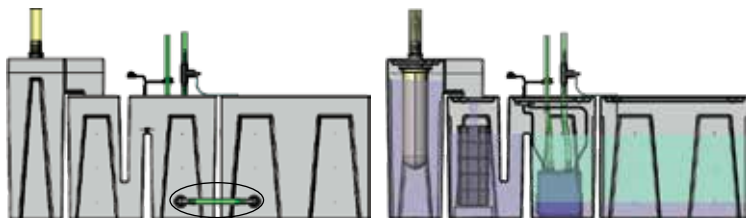

LOW BULKHEAD CONNECTION

HIGH EVAPORATION CAPACITY

## REFUGIUM CONFIGURATION

### CONNECT RESERVOIR HIGH

The water will not equalize past the height of the connecting bulkhead, therefore the reservoir tub will stay full even when the evaporation/pump chamber of the baffle tub water level gets low. In this configuration the reservoir tub will behave more like a refugium tub. This configuration has many possible uses such as growing live plants, live rock, feeder fish, even a quarantine/medication tank so long as you control cross contamination with the other tubs while the fish are being quarantined. If better viewing is desired for planted refugiums—we also make glass reservoir tanks of a similar footprint that can be connected in line in the same fashion. (See p. 6) for an example of glass reservoir tub in use.

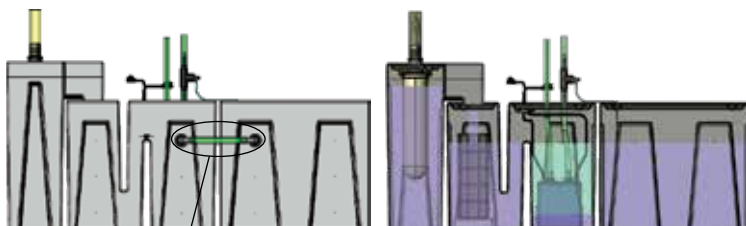

HIGH BULKHEAD EQUILIBRIUM CONNECTION

HIGH REFUGIUM CAPACITY

## KEY FEATURES OF ALL SEAMLESS SUMP® TUBS:

- One piece molded construction—NO SEAMS, NO WELDS, NO LEAKS!
- 1200GPH, 2400GPH, 3600GPH, 4800GPH, and higher configurations available!
- Glass lids—no warping or yellowing, great for UV lights
- Made of High Density Polyethylene
- Far superior to acrylic or glass for sump use—No more brittle, stale, "old tank" syndrome
- Six different tubs are easily interconnected and expandable for many configurations
- Massive 18" filter socks come standard—Made custom for the seamless sumps®
- Fits in most commercially available stands from the front!
- Great for both salt and fresh water tanks—Compartmentalizes the various filtration tasks
- Optimizes micro particle filtration, chemical/biological filtration, and aeration
- Easily transforms from a wet filter to a wet/dry filter—just add one media basket!
- Works great with the H2Overflow® system, Stealth Box®, or any other overflow
- Cord management grommets to easily plug in your heaters and pumps with minimal evaporation
- Pre molded pilot hole dimples on all surfaces at various heights—easy fabrication for many custom bulkhead configurations—DIY friendly!
- Commercial quality, professional look and feel—Engineered and Built to Last a LIFETIME®!

# CHECK OUT THESE VIDEOS TO LEARN MORE!

CHECK OUT THESE VIDEOS TO LEARN MORE!



## CUSTOM AQUARIUMS—BUILDING A LARGE AQUARIUM

This is a time-lapse video that shows two construction steps in building a custom glass aquarium at [CustomAquariums.com](http://CustomAquariums.com)—the set of the tank and first silicone seal.



## THE KING OF DIY—THE AQUARIUM RACKS!!!

“Today we venture to custom aquariums to get a first look at the new aquariums racks!”



## THE KING OF DIY—UNBOXING 10 AQUARIUMS

“Today we’re unboxing 10 fish tanks and racks for the aquarium gallery!”



## SALTWATER AMBITIONS—SEAMLESS SUMP® FROM CUSTOM AQUARIUMS

“If you are looking for a top of the line, adjustable sump solution, check out the Seamless Sump from [CustomAquariums.com](http://CustomAquariums.com). The Saltwater Ambitions build has a four part solution including a skimmer tub, sock tub, baffle tub, and RODI evaporation tank.”



## FISHOFHEX AQUATICS—MOVE DAY! 300 GALLON REEF

“Well it’s move day for the 300 gallon reef tank. We had eight people on hand to make this happen. We decided to move the tank on dollies while still in the shipping crate. We used the plywood from the stands crate to roll the dollies on in the backyard. The crate just fit through the fish room door and we only had to lift the tank once with six suction cups from [CustomAquariums.com](http://CustomAquariums.com).”

# CustomCages.com



## SUNCATCHER® LARGE WALK-IN BIRD AVIARIES, OUTDOOR CAT ENCLOSURES

These huge, powder coated/anodized indoor and outdoor aviaries are walk-in friendly, weather resistant, and easy to assemble! Safety catches allow access to your birds without fear of escape and allow you to connect multiple units together. Our SunCatcher® cat cages and cat condos give outdoor freedom to indoor cats! You and your pets can bask together in the sun on your patio without fear of escape or danger from predators, and with plenty of room to play and explore the great outdoors!



## MAJESTIC® FURNITURE STYLE WOOD BIRD CAGES, WOODEN REPTILE CAGES

These beautiful furniture style bird cages and reptile cages make amazing setups for your pets and are a great addition to any home! We offer a vast selection of custom cage designs such as corner cages, coffee table cages, and more! We have our own proprietary design featuring a solid Oak exterior and anodized aluminum lined interior with the largest selection of custom cage options available making our line of designer custom enclosures not only beautiful but functional. Our anodized aluminum frame also guarantees against wood chewing from the inside in bird cages and protects from moisture in reptile cages! **MADE IN THE USA!**



## HYBRID® ALUMINUM FRAMED BIRD CAGES & REPTILE CAGES

Our custom made build to order Hybrid® Bird Cages, Reptile Cages, and Small Animal Cages are all custom tailored for your specific needs. Stackable, expandable, and easy to assemble, our aluminum framed Hybrid® reptile enclosures and bird cages are safe, secure, and made in the USA. With our one of a kind Hybrid® Custom Cage Configurator, you can custom build and order your dream enclosures online!



## VISION REPTILE RACKS, CAGES, BOWLS & TUBS FOR SNAKES, REPTILES, MICE, RATS, RODENTS & HYDROPONICS SYSTEMS

Vision products include various snake breeding racks and cages, reptile rack systems, and more. Our Versa-Rack tub system, Vision Cages, tubs, bowls, and hides are designed to meet the needs of snake, lizard, and small animal breeders and pet owners. Vision racks and cages are safe, strong, dependable, versatile, and provide a solution for any enclosure need. All Vision reptile racks and snake breeding cages are stackable and save space. Vision products are manufactured in the USA. with the highest-quality materials and have been trusted reptile breeding cages for more than 20 years.



customcages.com/suncatcher20

# SUNCATCHER® CAGE FEATURES & ACCESSORIES

## SUNCATCHER® ENCLOSURES KEY FEATURES:

- **ALL WEATHER** Black Anodized Aluminum Frame standard which will **NEVER** rust, chip, or corrode—*Silver/Grey anodized aluminum also available for an extra charge*
- Many wire opening sizes/diameters available
- Laminate tempered/regular glass, acrylic substitutions available for any panel
- Pull out floors and trays, removable linoleum floor, and tray liners
- Cage covers and casters available



customcages.com/suncatcherconfig20

**ONLINE CUSTOM CONFIGURATOR!**  
BUILD YOUR COMPLETE DREAM ENCLOSURE  
ONLINE & GET INSTANT PRICING!



## LAMINATE OPTIONS



Black Aluminum    Black Granite    Natural Granite    Cambridge Cherry    English Oak    Golden Oak    Prestige Maple

\*Due to printing variations, colors may not be accurate. Sample kits available upon request.

## SILVER/GREY ANODIZED ALUMINUM



## BLACK ANODIZED ALUMINUM



## PULL OUT TRAYS & FLOORS



## SAFETY CATCH

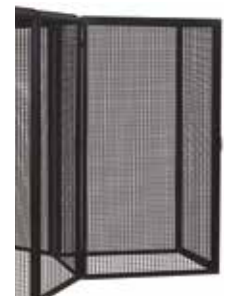

## WIRE OPTIONS—POWDER COATED & STAINLESS STEEL

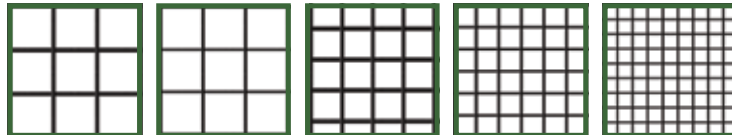

1.5 x 1.5 x 0.162    1.5 x 1.5 x 0.092"    1 x 1 x 0.120"    0.75 x 0.75 x 0.092"    0.5 x 0.5 x 0.063"

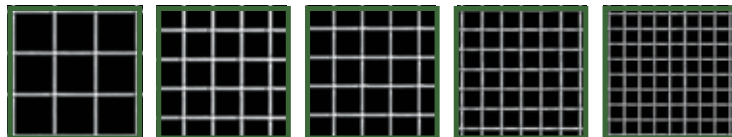

1.5 x 1.5 x 0.162    1 x 1 x 0.162"    1 x 1 x 0.120"    0.75 x 0.75 x 0.092"    0.5 x 0.5 x 0.092"

## GLASS PANELS



## DIVIDERS



## CASTERS



## FREEDOM TUBE & DOORS



## FRIENDLY FEEDER®



## ROTATING FEEDER®



## TRAY LINERS





## SUNCATCHER® LARGE WALK-IN BIRD CAGES

Welcome to our beautiful line of Suncatcher® indoor and outdoor bird enclosures. Since our beginning we have been dedicated to providing pet owners and commercial breeders alike with attractive, quality environments for their pets and livestock at affordable prices. We definitely believe that more is better when it comes to cubic footage for animal environments. You will not find more attractive, versatile, spacious, or quality outdoor bird cages anywhere else!

These huge walk-in friendly bird aviaries come in a variety of wire gauges and sizes. Suncatcher® bird cages come standard with 1" x 1" x .120" black powder coated wire with many other panel options available. They are weather-resistant and easy to assemble! You and your feathered flock will love the features our Suncatcher® bird cages & enclosures have, such as safety catches (for your outdoor aviary), connectable sections (outdoor bird cages), stainless steel rotating feeders® or Friendly Feeders® (for each indoor and outdoor large bird aviary), and taller, larger, outdoor bird aviary sizes offered at an even more affordable price! We even have huge double and triple bird aviary configurations!



### 8' DIAMETER x 72" TALL LARGE DOUBLE BIRD CAGE

The 8' Diameter X 72" tall large double bird cage is two Suncatcher® cages joined with a safety catch with wire or glass panels and optional background images. Accessory options include rotating feeding stations, Friendly Feeder® perches, coconut cups, ribbonwood perches, java wood perches, therapeutic corner perches, therapeutic perches, sandblasted playstands, formable ropes, large, medium, and small hang toys, deluxe play arena, and more! Bird accessories are sold separately—see p. 46.



4' DIAMETER x 72" TALL INDOOR/OUTDOOR AVIARY



4' DIAMETER x 48" TALL INDOOR/OUTDOOR AVIARY

\*Pictured in Silver/Gray Anodized Aluminum



4' DIAMETER x 48" TALL INDOOR/OUTDOOR AVIARY

WATCH VIDEO TO LEARN MORE ABOUT OUR SUNCATCHER® BIRD ENCLOSURES!



\*Please visit CustomCages.com to learn more about our cage materials and custom options. Please call or see website for details and pricing.

# SUNCATCHER® BIRD CAGES & ENCLOSURES

ALL SIZES ARE CUSTOMIZABLE! CHOOSE ANY PANEL TYPE (SEEN ON P. 19)



5' DIAMETER x 48" TALL  
INDOOR/OUTDOOR AVIARY



5' DIAMETER x 72" TALL  
INDOOR/OUTDOOR AVIARY



6' DIAMETER x 72" TALL  
INDOOR/OUTDOOR AVIARY



6' DIAMETER x 96" TALL  
INDOOR/OUTDOOR AVIARY



8' DIAMETER x 72" TALL  
INDOOR/OUTDOOR AVIARY



10' DIAMETER x 96" TALL  
INDOOR/OUTDOOR AVIARY



96"H x 90"L x 60"D  
INDOOR/OUTDOOR AVIARY



96"H x 150"L x 90"D  
DIVIDED INDOOR/OUTDOOR AVIARY



8' DIAMETER x 120" TALL INDOOR/OUTDOOR AVIARY



12' DIAMETER x 96" TALL INDOOR/OUTDOOR AVIARY





## SUNCATCHER® CAT CAGES & ENCLOSURES

Finally... your indoor cat can enjoy the freedom of the outdoors! Our revolutionary SunCATcher® outdoor cat enclosures allow your cat to come and go outside as it pleases and bask in the sun's natural rays without the fear of escape!

Walk-in friendly, lockable, and durable, our outdoor cat enclosures will allow you and your pets to bask together in the sun on your patio, deck, or anywhere near a window without fear of escape or danger, and with plenty of room to play and explore the great outdoors! We also have a full line of accessories available, including solid cedar shelves, plush cat trees, catwalks, Friendly Feeders® for food, water and treats, and connector kits to make your SunCATcher® Enclosure an outdoor paradise for your furry felines! **A GREAT ADDITION TO ANY HOME, OUR SUNCATCHER® OUTDOOR CAT CAGES & ENCLOSURES WILL BE A TREAT FOR YOU AND YOUR CATS FOR YEARS TO COME!**



8' DIAMETER x 72" TALL LARGE TRIPLE CAT CAGE

### DOUBLE & TRIPLE CAT CAGES

The double and triple cat cages are enclosures joined with one or two safety catches and include options of wire/glass panels and background images. Accessory options include rotating feeding stations, cedar outdoor friendly cat tree condos, cedar and carpeted catwalks and cat shelves, and more! Cat accessories are sold separately. Please contact us at (800) 941-2243 for a quote!



8' DIAMETER x 72" TALL LARGE DOUBLE CAT CAGE



4' DIAMETER x 72" TALL INDOOR/OUTDOOR CAT CAGE



4' DIAMETER x 48" TALL INDOOR/OUTDOOR CAT CAGE



5' DIAMETER x 48" TALL INDOOR/OUTDOOR CAT CAGE

WATCH VIDEO TO LEARN MORE ABOUT OUR SUNCATCHER® CAT ENCLOSURES!



YouTube

customcages.com/suncatchercatoverview20

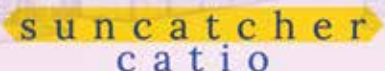

\*Please visit CustomCages.com to learn more about our cage materials and custom options. Please call or see website for details and pricing.

# SUNCATCHER® CAT CAGES & ENCLOSURES

SUNCATCHER® CAT CAGES & ENCLOSURES



5' DIAMETER x 72" TALL  
INDOOR/OUTDOOR CAT CAGE



6' DIAMETER x 72" TALL  
INDOOR/OUTDOOR CAT CAGE



6' DIAMETER x 96" TALL  
INDOOR/OUTDOOR CAT CAGE



8' DIAMETER x 72" TALL  
INDOOR/OUTDOOR CAT CAGE



96"H x 150"L x 90"D INDOOR/OUTDOOR CAT CAGE



12' DIAMETER x 96" TALL INDOOR/OUTDOOR CAT CAGE



10' DIAMETER x 96" TALL INDOOR/OUTDOOR CAT CAGE



96"H x 90"L x 60"D INDOOR/OUTDOOR CAT CAGE

More sizes, options, and configurations available! Please visit [CustomCages.com](http://CustomCages.com) to learn more!



8' DIAMETER x 120" TALL INDOOR/OUTDOOR CAT CAGE

## OUR SUNCATCHERS® ARE ALSO GREAT ENCLOSURES FOR CHICKENS & LIZARDS!



### STACIE'S CHICKEN ENCLOSURE

"When Stacie went searching for a way to protect her chickens from predators, she found the [CustomCages.com](http://CustomCages.com) Suncatcher® enclosure to be a great solution."

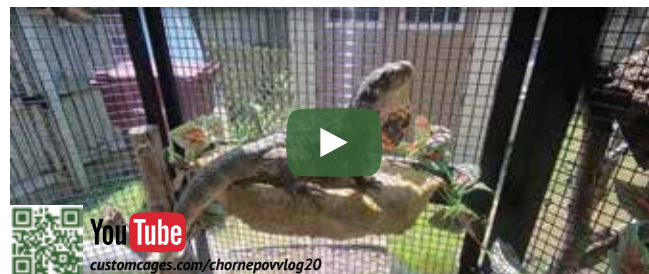

### CHUCK HORNE—POV—MOVING IGUANAS OUTSIDE FOR THE SUMMER!

"With the GoPro strapped to my head, I move my Honduran Spiny Tail Iguanas, Bossk and Tiamat, into their outdoor summer enclosure!"

[VisionProducts.us](http://VisionProducts.us) | (920) 886-1220

[CustomCages.com](http://CustomCages.com) | (800) 941-2243

[CustomAquariums.com](http://CustomAquariums.com) | (844) 244-8265



## SUNCATCHER® DOG KENNELS

**ADD BEAUTY TO YOUR LANDSCAPE—NO MORE UNSIGHTLY CHAIN LINK!**

Suncatcher® Enclosures also work great as kennels for dogs and other small animals! Our enclosures look much nicer than chain link, but are not nearly as expensive as ornamental. We have a multitude of wire diameters and thickness as well as shapes, sizes, and two color options available (black and silver/grey—see p. 19). Additional options available include pitched roofs (steel or stainless) to keep your pet out of the rain and snow, wire roofs to keep pets in and varmints out, and wire floors to keep even the most tenacious dog or other pet from digging holes under the kennel! Our safety catches are also a nice feature (see p. 19) which make sure your dog does not escape while feeding. Enclosures come with stainless steel door handles that safely secure the doors and easily accept a padlock for additional security. **SEE OUR ONLINE CONFIGURATOR TO CUSTOM CONFIGURE YOUR KENNEL AND GET AN INSTANT PRICE QUOTE!**



See p. 46 for information on our rotating feeders. Perfect for dogs, cats, birds, and other small animals!

## SUNCATCHER® MULTI-UNIT KENNELS

**SUNCATCHER® ENCLOSURES** work great for zoos, humane centers, breeding facilities, rescues, and private facilities. The kennel enclosures can have optional pitched or wire roofs (or both), wire floors, and many other custom options. They can be infinitely long and over 20' deep, with many ways to configure divider scenarios and door placement. Enclosures come with stainless steel door handles that safely secure the doors and easily accept a padlock for additional security. Like any of our products, we have a vast range of customization options to suit your specific needs! Great for anything from birds, cats, dogs, and much more!

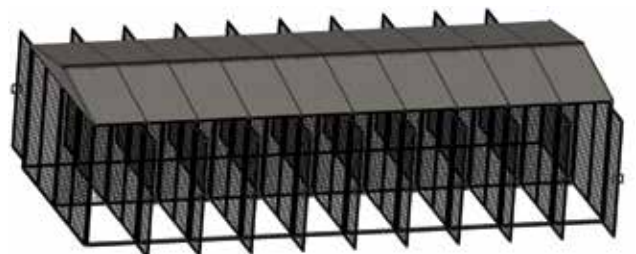
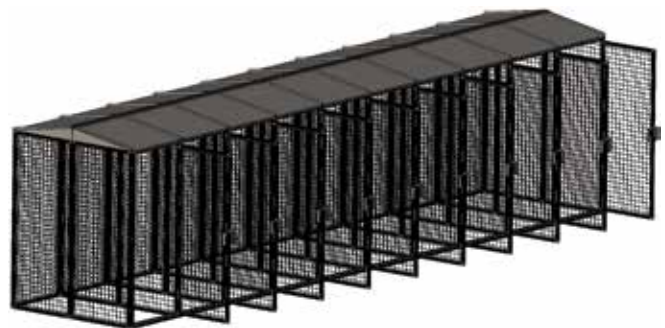



customcages.com/majestic20

# MAJESTIC® CAGE FEATURES & ACCESSORIES

## CLASSIC



## STANDARD STYLES

## CONTEMPORARY



## STANDARD FINISHES



Natural Oak Stain on Oak Wood



Dark Walnut Stain on Oak Wood



Colonial Oak Stain on Oak Wood



Autumn Cherry Stain on Oak Wood



Black Paint on Maple Wood



White Paint on Maple Wood

\*Due to printing variations, colors may not be accurate. Sample kits available upon request.

### MAJESTIC® ENCLOSURES KEY FEATURES:

- **MORE VIEWING AREA** than ANY other furniture-style cage system on the market!
- **HANDCRAFTED TO ORDER IN THE UNITED STATES!**
- **SOLID OAK** exterior frame (Hard Maple, Cherry wood, and custom woods available!)
- **FULLY LINED ANODIZED ALUMINUM INTERIOR GUARANTEED AGAINST WOOD CHEWING** on the inside.
- **EXPANDABLE** – Connect two or more enclosures together!
- **MODULAR** – Get any size enclosure into your vehicle, through doorways, around corners, or up stairs!
- **TRAY & FLOOR PULL OUT WITHOUT OPENING THE CAGE DOOR!** A function most of the competition does not have!

### GUARANTEED AGAINST WOOD CHEWING FROM THE INSIDE!



### MODULAR & TRANSPORTABLE



### EXPANDABLE



### CAGE COVERS



### DECORATIVE CROWN



### CASTERS



### SEED CATCHERS



### REMOVABLE DIVIDERS



### PULL OUT FLOORS/TRAYS/LINERS



*quality*  
**CUSTOMIZATION**

LOCKING TRAY DONE FOR A NURSING HOME

CUSTOM "DISTRESSED WHITE" DONE FOR A CUSTOMER TO MATCH THEIR DECOR

CUSTOM BUTTERFLY ENCLOSURE DONE FOR A MUSEUM EXHIBIT

See p. 26 for details on trays & dividers





## MAJESTIC® FURNITURE STYLE WOODEN BIRD CAGES

Our Majestic® bird enclosures offer more viewing area than ANY OTHER furniture style bird cage system on the market. All our Majestic® custom bird cages & enclosures are made with a solid Oak exterior frame (hard Maple wood, Cherry wood, and other custom woods available), and fully lined with an anodized aluminum frame which guarantees them against wood chewing from the inside!

## OUR CAGE SPECIALS

Give your pet room to stretch! These enormous Majestic® custom bird cages & enclosures are our most popular Majestic® Bird Cage Specials—with a solid oak frame and fully lined anodized aluminum interior, all our wooden bird cages are GUARANTEED against wood chewing from the inside! Plenty of room for multiple birds or small animals in many of our aviaries. Even large wood bird cages like this can be equipped with **PULL OUT FLOORS** and **PULL OUT TRAYS**, making cleanup of any wood bird cage a breeze! Optional **PULL OUT DIVIDERS** separate a cage to house multiple birds, or add a hood for lighting or a stand for storage of all your bird supplies.

All our floors and trays pull out without opening the bird cage door, a function most of the competition does not have, and the modular system allows you to get any size enclosure into your car or truck, through your doorway, around corners, and up stairways! It also allows for easy storage or shipping if you are not using your cage. You will not find custom bird cages with this level of versatility anywhere else!



MB01 BIRD CAGE – 72”H x 144”L x 48”D

MB02 BIRD CAGE 72”H x 144”L x 36”D

SCAN QR CODE OR VISIT LINK TO LEARN MORE ABOUT OUR MAJESTIC® BIRD ENCLOSURES!



MB03 BIRD CAGE – 72”H x 96”L x 48”D  
MB04 BIRD CAGE – 72”H x 96”L x 36”D



MB05 BIRD CAGE – 60”H x 60”L x 36”D

\*Please visit CustomCages.com to learn more about our cage materials and custom options. Please call or see website for details and pricing.

# MAJESTIC® BIRD CAGES & ENCLOSURES



**MB06 BIRD CAGE –**  
48”H x 72”L x 36”D



**MB08 BIRD CAGE –**  
72”H x 48” x 36”D



**MB07 BIRD CAGE –**  
72”H x 48”L x 48”D  
Similar Enclosure Pictured,  
Exact Not Shown  
**MB09 BIRD CAGE –**  
72”H x 48”L x 24”D  
Similar Enclosure Pictured,  
Exact Not Shown



**MB11 BIRD CAGE –**  
60”H x 48”L x 24”D



**MB10 BIRD CAGE –**  
60”H x 48”L x 36”D  
Similar Enclosure Pictured,  
Exact Not Shown



**MB13 BIRD CAGE –**  
48”H x 48”L x 24”D



**MB12 BIRD CAGE –**  
48”H x 48”L x 36”D  
**MB14 BIRD CAGE –**  
36”H x 36”L x 24”D  
Similar Enclosure Pictured,  
Exact Not Shown



**MB15 BIRD CAGE –**  
30”H x 30”L x 18”D



**MB14 BIRD CAGE –**  
36”H x 36”L x 24”D



**MBC1 CORNER BIRD CAGE –** 60”H x 23<sup>1/4</sup>”  
(DOOR) x 17<sup>5/8</sup>”(SIDES) x 34”(BACK)



**MBC2 CORNER BIRD CAGE –** 60”H x 35<sup>1/4</sup>”  
(DOOR) x 23<sup>5/8</sup>”(SIDES) x 48<sup>1/2</sup>”(BACK)





## MAJESTIC® FURNITURE STYLE WOODEN REPTILE CAGES

Our Majestic® custom reptile cages offer more viewing area than ANY OTHER furniture style reptile enclosure system on the market. All are made with a solid Oak exterior frame (hard Maple wood, Cherry wood, and other custom woods available), and fully lined with an anodized aluminum frame which protects them from moisture on the inside!

Our modular furniture style reptile cage system allows you to get any size enclosure into your car or truck, through your doorway, around corners, and up stairways! It also allows for easy storage or shipping if you are not using your cage. You will not find wooden reptile cages with this level of versatility anywhere else!

## OUR CAGE SPECIALS

Give your pet room to stretch! These enormous Majestic® custom reptile cages & enclosures are our most popular Majestic® Reptile Cage Specials—with a solid oak frame and fully lined anodized aluminum interior, plenty of room for multiple bearded dragons, lizards, or snakes in many of our reptile enclosures. Optional **PULL OUT DIVIDERS** separate a reptile cage to house multiple species, or add a hood for lighting or a stand for storage of all your herp supplies.



MR16 REPTILE CAGE – 24”H x 96”L x 24”D

SCAN QR CODE OR VISIT LINK TO LEARN MORE ABOUT OUR MAJESTIC® REPTILE ENCLOSURES!



MR02 REPTILE CAGE – 72”H x 144”L x 36”D  
MR01 REPTILE CAGE – 72”H x 144”L x 48”D  
Similar Enclosure Pictured, Exact Not Shown



MR04 REPTILE CAGE – 72”H x 96”L x 36”D  
MR03 REPTILE CAGE – 72”H x 96”L x 48”D  
Similar Enclosure Pictured, Exact Not Shown

\*Please visit CustomCages.com to learn more about our cage materials and custom options. Please call or see website for details and pricing.

# MAJESTIC® REPTILE CAGES & ENCLOSURES



MR05 REPTILE CAGE –  
60”H x 60”L x 36”D



MR06 REPTILE CAGE –  
48”H x 72”L x 36”D



BRIAN MEIER'S CHINESE WATER DRAGON CAGE



YouTube  
customcages.com/brianmeier20

Brian purchased a custom Majestic® reptile enclosure for his two new Chinese water dragons. This is Brian's second *Custom Cages* enclosure.



MR08 REPTILE CAGE –  
72”H x 48”L x 36”D



MR07 REPTILE CAGE –  
72”H x 48”L x 48”D  
Similar Enclosure Pictured,  
Exact Not Shown



MR11 REPTILE CAGE –  
60”H x 48”L x 24”D



MR10 REPTILE CAGE –  
60”H x 48”L x 36”D  
Similar Enclosure Pictured,  
Exact Not Shown

MR09 REPTILE CAGE –  
72”H x 48”L x 24”D  
Similar Enclosure Pictured,  
Exact Not Shown



MR13 REPTILE CAGE –  
48”H x 48”L x 24”D



MR14 REPTILE CAGE –  
36”H x 36”L x 24”D



MR17 REPTILE CAGE –  
24”H x 72”L x 24”D



MRC1 REPTILE CAGE – 60”H x 23 1/4”  
(DOOR) x 17 5/8” (SIDES) x 34” (BACK)

MR15 REPTILE CAGE –  
30”H x 30”L x 18”D  
Similar Enclosure Pictured,  
Exact Not Shown

MR12 REPTILE CAGE –  
48”H x 48”L x 36”D  
Similar Enclosure Pictured,  
Exact Not Shown

MR18 REPTILE CAGE –  
24”H x 48”L x 24”D  
Similar Enclosure Pictured,  
Exact Not Shown



# HYBRID® CAGE FEATURES & ACCESSORIES

customcages.com/hybrid20



HYBRID® CAGE FEATURES & ACCESSORIES

## HYBRID® KEY FEATURES:

- **THE MOST CUSTOM OPTIONS ANYWHERE!** Choose hoods, stands, pull out floors and trays, image backgrounds, feeders, toys, furniture, seed catchers, and more!
- **DURABLE, PET SAFE MATERIALS**
- **MODULAR, TRANSPORTABLE & EASY ASSEMBLY!** Go up stairs, around corners, or in or out of a vehicle with ease!
- **EXPANDABLE, STACKABLE, DURABLE!** Change your size or add a hood or stand at any time!
- **HANDMADE TO ORDER IN THE USA!**

## LAMINATE OPTIONS

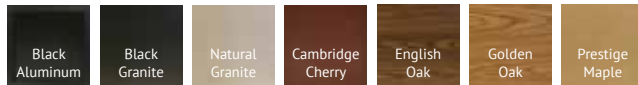

\*Due to printing variations colors may not be accurate. Sample kits available upon request.

## ADVANCED DESIGN

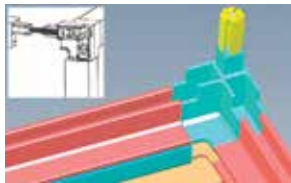

### CORNER JOINT SYSTEM

Revolutionary system allows for quick assembly and easy stackability, makes additions of pull out floors, pull out trays, or casters a breeze.



### INTERLOCKING DOOR SYSTEM

Keyed lock mechanism not only keeps doors closed, but pins doors together preventing even the most determined critters from spreading them apart and escaping.

### COMPLETE STACKABILITY

No racking. Revolutionary corner joint and pin system lock enclosures, hoods, and stands together or use to install casters.

customcages.com/hybridconfig20



**ONLINE CUSTOM CONFIGURATOR!  
BUILD YOUR COMPLETE HYBRID® ENCLOSURE  
ONLINE & GET INSTANT PRICING!**



## MODULAR & TRANSPORTABLE



## EASY ASSEMBLY



Same cage disassembled

## EXPANDABLE



Single unit cage



Double unit (same cage with 1 added unit)

## STACKABLE



## INTERCHANGEABLE PANELS



Acrylic Panels



Glass Panels



Composite Side Panels

## DURABLE PET SAFE CAGING



## REMOVABLE DIVIDERS



## CAGE COVERS



## SEED CATCHERS



## PULL OUT FLOORS & TRAYS



## CASTERS

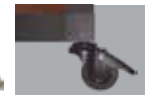

Heavy Duty Casters for Large H3 Cages/Stands



Casters for H2/H3 Cages/Stands





customcages.com/hybridbird20

# HYBRID® BIRD CAGES & ENCLOSURES

## OUR BIRD CAGE SPECIALS

Give your pet room to stretch! These enormous custom Hybrid® bird cages & bird enclosures are our most popular Hybrid® bird cage specials! Plenty of room for multiple birds or small animals in many of our custom bird cages. And even large bird cages like this can be equipped with **PULL OUT FLOORS** and **PULL OUT TRAYS**, making cleanup of any bird cage a breeze! Optional **PULL OUT DIVIDERS** separate a cage to house multiple birds. Add a hood for lighting or a stand for storage of all your bird supplies.



HB03 BIRD CAGE – 72”H x 96”L x 48”D H3



HB01 BIRD CAGE – 72”H x 144”L x 48”D H3

Similar Enclosure Pictured, Exact Not Shown

HB02 BIRD CAGE – 72”H x 144”L x 36”D H3

Similar Enclosure Pictured, Exact Not Shown

HB04 BIRD CAGE – 72”H x 96”L x 36”D H3

Similar Enclosure Pictured, Exact Not Shown



HB05 BIRD CAGE – 60”H x 60”L x 36”D H3



HB06 BIRD CAGE – 48”H x 72”L x 36”D H3

SCAN QR CODE OR VISIT LINK TO LEARN MORE ABOUT OUR HYBRID® BIRD ENCLOSURES!



YouTube  
customcages.com/hybridbirdoverview20



\*Please visit CustomCages.com to learn more about our cage materials and custom options. Please call or see website for details and pricing.

VisionProducts.us | (920) 886-1220

CustomCages.com | (800) 941-2243

CustomAquariums.com | (844) 244-8265



**HB08 BIRD CAGE –**  
72”H x 48”L x 36”D H3



**HB07 BIRD CAGE –**  
72”H x 48”L x 48”D H3  
**HB09 BIRD CAGE –**  
72”H x 48”L x 24”D H3  
Similar Enclosure Pictured,  
Exact Not Shown



**HB11 BIRD CAGE –**  
60”H x 48”L x 24”D H3



**HB10 BIRD CAGE –**  
60”H x 48”L x 36”D H3  
Similar Enclosure Pictured,  
Exact Not Shown



**HB13 BIRD CAGE –**  
48”H x 48”L x 24”D H3



**HB12 BIRD CAGE –**  
48”H x 48”L x 36”D H3  
Similar Enclosure Pictured,  
Exact Not Shown



**HB14 BIRD CAGE –**  
36”H x 36”L x 24”D H2



**HB15 BIRD CAGE –**  
30”H x 30”L x 18”D H2  
Similar Enclosure Pictured,  
Exact Not Shown



**HBM01 BIRD CAGE 3-3 COMBO –**  
84”H x 72”L x 24”D H3



**HBM02 BIRD CAGE 3-2 COMBO –**  
84”H x 72”L x 24”D H2



**HBM04 BIRD CAGE 2-4 COMBO –**  
84”H x 48”L x 24”D H2



**HBM05 BIRD CAGE 2-3 COMBO –**  
84”H x 36”L x 24”D H2



\*Please visit CustomCages.com to learn more about our cage materials and custom options. Please call or see website for details and pricing.



customcages.com/hybridreptile20

# HYBRID® REPTILE CAGES & TANKS

## OUR REPTILE CAGE SPECIALS

Give your pet room to stretch! These enormous custom Hybrid® reptile cages & reptile enclosures are our most popular Hybrid® reptile cage specials! Plenty of room for multiple herptiles in many of our enclosures. Optional **PULL OUT DIVIDERS** separate a cage to house multiple species, or add a hood for lighting or a stand for storage of all your herping supplies.



HR05 REPTILE CAGE – 60”H x 60”L x 36”D H3



HR06 REPTILE CAGE – 48”H x 72”L x 36”D H3



HR01 REPTILE CAGE – 72”H x 144”L x 48”D H3  
HR02 REPTILE CAGE – 72”H x 144”L x 36”D H3  
Similar Enclosure Pictured, Exact Not Shown



HR03 REPTILE CAGE – 72”H x 96”L x 48”D H3  
HR04 REPTILE CAGE – 72”H x 96”L x 36”D H3  
Similar Enclosure Pictured, Exact Not Shown

SCAN QR CODE OR VISIT LINK TO LEARN MORE ABOUT OUR HYBRID® REPTILE ENCLOSURES!

Hybrid Enclosures

for Reptiles

YouTube

customcages.com/hybridreptileoverview20





**HR08 REPTILE CAGE** –  
72”H x 48”L x 36”D H3  
**HR07 REPTILE CAGE** –  
72”H x 48”L x 48”D H3  
Similar Enclosure Pictured,  
Exact Not Shown  
**HR09 REPTILE CAGE** –  
72”H x 48”L x 24”D H3  
Similar Enclosure Pictured,  
Exact Not Shown



**HR11 REPTILE CAGE** –  
60”H x 48”L x 24”D H3  
**HR10 REPTILE CAGE** –  
60”H x 48”L x 36”D H3  
Similar Enclosure Pictured,  
Exact Not Shown



**HR13 REPTILE CAGE** –  
48”H x 48”L x 24”D H3  
**HR12 REPTILE CAGE** –  
48”H x 48”L x 36”D H3  
Similar Enclosure Pictured,  
Exact Not Shown



**HR14 REPTILE CAGE** –  
36”H x 36”L x 24”D H2  
**HR15 REPTILE CAGE** –  
30”H x 30”L x 18”D H2  
Similar Enclosure Pictured,  
Exact Not Shown

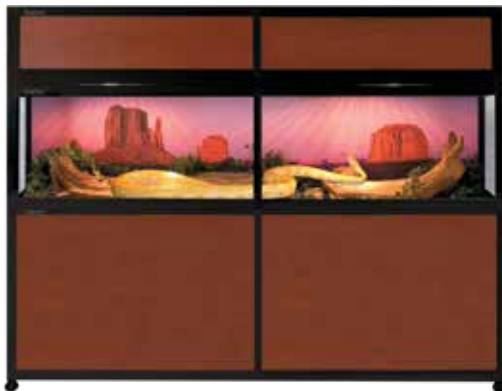

**HR16 REPTILE CAGE** –  
24”H x 96”L x 24”D H3



**HR17 REPTILE CAGE** –  
24”H x 72”L x 24”D H3



**HR18 REPTILE CAGE** –  
24”H x 48”L x 24”D H2  
**HR19 REPTILE CAGE** –  
18”H x 36”L x 18”D H2  
Similar Enclosure Pictured,  
Exact Not Shown



**HRM01 REPTILE CAGE**  
3-2-1 COMBO –  
72”H x 72”L x 24”D H3



**HRM05 REPTILE CAGE**  
2 x 8 x 2 COMBO –  
84”H x 96”L x 24”D H3



**HRM08 REPTILE CAGE**  
2 x 4 x 2 COMBO –  
84”H x 48”L x 24”D H2



**HRM11 REPTILE CAGE**  
1 1/2 x 4 x 2 COMBO  
90”H x 48”L x 24”D H2



\*Please visit CustomCages.com to learn more about our cage materials and custom options. Please call or see website for details and pricing.



# VISION RACKS & CAGES



## STACKABLE SNAKE, LIZARD, MAMMAL & REPTILE CAGES

Vision Products provides cages for reptile-keeping enthusiasts. Whether you are keeping snakes, lizards, box turtles, tortoises, tarantulas, insects, or even small mammals such as hamsters, rats, and mice, these quality-made cages are an excellent choice for displaying, housing, and breeding your animals. Additionally, the cages from Vision were designed to make controlling temperature, light, and humidity a much easier process for reptile and mammal owners and breeders. Each cage's material and sliding glass doors are strong and durable, lasting for many years. Finally, our cages are designed so that it is very easy to access the interior of the cage for cleaning, scaping, and disinfecting.



VISION CAGE MODEL 734 - 44"H x 80"L x 28"D



VISION CAGE MODEL 632 - 18"H x 72"L x 36"D



VISION CAGE MODEL 622 - 18"H x 72"L x 28"D

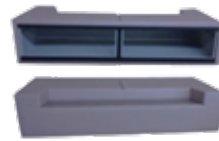

VISION CAGE MODEL 600 - 16"H x 72"L x 28"D



VISION CAGE MODEL 433 - 28"H x 48"L x 28"D



VISION CAGE MODEL 432 - 18"H x 54"L x 36"D



VISION CAGE MODEL 422 - 18"H x 48"L x 28"D



VISION CAGE MODEL 415 - 21"H x 48"L x 16"D



VISION CAGE MODEL 400 - 14"H x 48"L x 26"D



VISION CAGE MODEL 332 - 18"H x 36"L x 28"D



VISION CAGE MODEL 322 - 21"H x 36"L x 23"D



VISION CAGE MODEL 222 - 24"H x 28"L x 24"D



VISION CAGE MODEL 221 - 12"H x 28"L x 22"D



VISION CAGE MODEL 215 - 20"H x 28"L x 14"D



VISION CAGE MODEL 211 - 14"H x 24"L x 22"D



VISION CAGE MODEL 111 - 16"H x 24"L x 12"D

## NOW OFFERING WIRE DOORS!



SCAN QR CODE OR VISIT LINK TO LEARN MORE ABOUT VISION CAGES!



YouTube

visionproducts.us/cagesoverview20



\*Please visit [VisionProducts.us](http://VisionProducts.us) to learn more about our cage materials and custom options. Please call or see website for details and pricing.



## RACKS FOR SNAKE, REPTILE, MAMMAL & RODENT BREEDING

Vision Racks are used for breeding and housing larger numbers of snakes, reptiles, and small animals in places where a space-saving rack with tubs is advantageous. The Vision Rack is safe, strong, dependable, and highly versatile. Assembly of our breeding racks are quick and easy, and once assembled, any additional levels of breeder tubs can be added in just a few minutes. Changing the size of tub is easy too, just exchange the spacers between the shelves, or rotate the entire rack 90° and insert different tubs from a different side. The light-weight rack includes locking wheels for easy movement through doors and into tight spaces. A heat cable can be purchased and installed easily on the Vision Rack. Ventilation is built into the shelves of the breeding rack, as are clips to hold the heat cable in many configurations. Heat tape can be installed on top of the clips in the shelves of rack and still leave space around the heat tape for proper ventilation. Stops and guides can also be purchased to make sure the breeding tubs stay in place and are not accidentally pushed out of the rack. Snake breeders will appreciate that our tub rims are thick, easy to grab, and provide a wide seal between the top edge of the tub and the Versa-Rack shelf above. A thicker bottom provides some protection from hot spots from the heat cable or heat tape and ensures that long exposure to heat will not damage the tub. Additionally, the tub bottom is flat inside and out, making the tub easier to clean and harder for reptiles such as snakes to push water dishes and flip them over. Our racks and tubs are trusted by thousands of snake, reptile, and small animal breeders around the world! Please visit [visionproducts.us](http://visionproducts.us) to see more breeding rack sizes! If you don't see the size and configuration you need listed on our website, please call us at (920) 886-1220 as we can create custom racks!



**8 LEVEL HATCHLING BREEDING RACK**  
(QTY. 48, MODEL V-15, 5 QUART TUBS) –  
Rack Height (+/- 1/2"), (Incl. Casters): 42.25"  
Rack Footprint: 34.5" X 21"  
Tub Size Description: 3.5" X 5" X 18"



**16 LEVEL HATCHLING BREEDING RACK**  
(QTY. 96, MODEL V-15, 5 QUART TUBS) –  
Rack Height (+/- 1/2"), (Incl. Casters): 78.25"  
Rack Footprint: 34.5" x 21"  
Tub Size Description: 3.5" x 5" x 18"



**16 LEVEL HATCHLING BREEDING RACK**  
(QTY. 64, MODEL V-18, 7 QUART TUBS) –  
Rack Height (+/- 1/2"), (Incl. Casters): 78.25"  
Rack Footprint: 34.5" x 21"  
Tub Size Description: 3.5" x 7.5" x 18"



**7 LEVEL HATCHLING BREEDING RACK**  
(QTY. 14, MODEL V-35, 21 QUART TUBS) –  
Rack Height (+/- 1/2"), (Incl. Casters): 54.38"  
Rack Footprint: 34.5" X 21"  
Tub Size Description: 5.3" x 15" x 20"



**11 LEVEL HATCHLING BREEDING RACK**  
(QTY. 22, MODEL V-35, 21 QUART TUBS) –  
Rack Height (+/- 1/2"), (Incl. Casters): 78.38"  
Rack Footprint: 34.5" x 21"  
Tub Size Description: 5.3" x 15" x 20"



**8 LEVEL HATCHLING BREEDING RACK**  
(QTY. 16, MODEL V-35S, 15 QUART TUBS) –  
Rack Height (+/- 1/2"), (Incl. Casters): 42.25"  
Rack Footprint: 34.5" X 21"  
Tub Size Description: 3.5" x 15" x 20"



**7 LEVEL HATCHLING BREEDING RACK**  
(QTY. 7, MODEL V-70 44 QUART TUBS) –  
Rack Height (+/- 1/2"), (Incl. Casters): 54.38"  
Rack Footprint: 34.5" x 21"  
Tub Size Description: 5.3" x 17" x 33"



**11 LEVEL HATCHLING BREEDING RACK**  
(QTY. 11, MODEL V-70, 44 QUART TUBS) –  
Rack Height (+/- 1/2"), (Incl. Casters): 79.88"  
Rack Footprint: 34.5" x 21"  
Tub Size Description: 5.3" x 17" x 33"

SCAN QR CODE OR VISIT LINK TO  
LEARN MORE ABOUT VISION RACKS!



**6 LEVEL HATCHLING BREEDING RACK**  
(QTY. 6, MODEL V-180 BOA, 180 QUART TUBS) –  
Rack Height (+/- 1/2"), (Incl. Casters): 78.75"  
Rack Footprint: 34.5" x 42"  
Tub Size Description: 9.5" x 31" x 40"



**10 LEVEL HATCHLING BREEDING RACK**  
(QTY. 10, STERILITE 1755, 32 QUART TUBS) –  
Rack Height (+/- 1/2"), (Incl. Casters): 78.63"  
Rack Footprint: 18.75" x 26"  
Tub Size Description: 6" x 23" x 16"

\*Please visit [VisionProducts.us](http://VisionProducts.us) to learn more about our cage materials and custom options. Please call or see website for details and pricing.



visionproducts.us/rodenttracks20

# VISION RODENT BREEDING RACKS

VISION RODENT BREEDING RACKS

## RODENT BREEDING RACKS

Vision Products has some of the highest reviewed and best quality rodent breeding racks on the market. Our space-saving racks are strong, dependable, and highly versatile. Assembly of our rodent breeding rack can be completed with ease and any adjustments or add-ons can be done in minutes. Every part of our rodent breeding racks has a purpose and have been methodically designed to give the best housing and breeding experience for your animals.

In addition, our custom rodent breeding racks provide great ventilation, light-weight movement, space for heating cables/tape, and lock-in wheels! Thousands of breeders around the world trust our rodent breeding racks and use them for housing and breeding small mammals like hamsters, gerbils, mice, rats, and other small animals.

If you have questions about size, assembly, pricing, shipping, or any other inquiries regarding our rodent breeding racks, please contact our experts at (920) 886-1220 and we will be happy to assist. Please see [visionproducts.us](http://visionproducts.us) for more sizes!

## RODENT BREEDING RACKS WITH TUBS & LIDS

The breeding racks for rodents we have pictured below have tubs and lids included with your purchase (if desired). At Vision, our tubs and lids provide space and safety and are quality-made using only safe materials.

## VISION TUB OVERVIEW

Our tubs are designed to fit seamlessly into our rack systems and are built for durability, using a plastic material that is much harder than the softer plastic of a typical bin. This hard plastic quality makes it much more difficult for your rodents to chew their way through the surface of the tub. In addition, these tubs are strong, durable, and less flexible than average tubs.

## VISION LID OVERVIEW

The patent-pending rodent lids available on our website are made specifically to fit our V-35 and V-35S tubs. A lot of engineering and attention to detail went into providing the most functional, durable lid at an affordable price! These lids are stamped and formed from a single piece of stainless steel material (not welded wire) which makes them stronger, easier to clean, and more durable for long term use. Our unique design has the best strength to open airflow ratio and protects your water bottle and the edge of tubs from chewing.



**5 LEVEL RODENT BREEDING RACK**  
(QTY. 10, MODEL V-35, 21 QUART TUBS) –  
Rack Height (+/- 1/2"), (Incl. Casters): 55.25"  
Rack Footprint: 34.5" x 21"  
Tub Size Description: 5.3" x 15" x 20"



**7 LEVEL RODENT BREEDING RACK**  
(QTY. 14, MODEL V-35, 21 QUART TUBS) –  
Rack Height (+/- 1/2"), (Incl. Casters): 78.75"  
Rack Footprint: 34.5" x 21"  
Tub Size Description: 5.3" x 15" x 20"



**8 LEVEL RODENT BREEDING RACK**  
(QTY. 16, MODEL V-35, 21 QUART TUBS) –  
Rack Height (+/- 1/2"), (Incl. Casters): 90.50"  
Rack Footprint: 34.5" x 21"  
Tub Size Description: 5.3" x 15" x 20"



**11 LEVEL RODENT BREEDING RACK**  
(QTY. 22, MODEL V-35S, 15 QUART TUBS) –  
Rack Height (+/- 1/2"), (Incl. Casters): 91.63"  
Rack Footprint: 34.5" x 21"  
Tub Size Description: 3.5" x 15" x 20"

**4 LEVEL RODENT BREEDING RACK**  
(QTY. 8, MODEL V-35, 21 QUART TUBS) –  
Rack Height (+/- 1/2"), (Incl. Casters): 43.50"  
Rack Footprint: 34.5" x 21"  
Tub Size Description: 5.3" x 15" x 20"  
Similar Enclosure Pictured, Exact Not Shown



**VISION TUBS – MODEL V-35 TUB**  
Tub Size Description: 5.3" x 15" x 20"  
Bulk pricing available. Please see our website.



**VISION TUBS – MODEL V-35S TUB**  
Tub Size Description: 3.5" x 15" x 20"  
Bulk pricing available. Please see our website.



**7 LEVEL RODENT BREEDING RACK**  
(QTY. 14, MODEL V-35S, 15 QUART TUBS) –  
Rack Height (+/- 1/2"), (Incl. Casters): 54.25"  
Rack Footprint: 34.5" x 21"  
Tub Size Description: 3.5" x 15" x 20"

**5 LEVEL RODENT BREEDING RACK**  
(QTY. 10, MODEL V-35S, 15 QUART TUBS) –  
Rack Height (+/- 1/2"), (Incl. Casters): 38.25"  
Rack Footprint: 34.5" x 21"  
Tub Size Description: 3.5" x 15" x 20"  
Similar Enclosure Pictured, Exact Not Shown



**RODENT LIDS**  
(FOR V-35 AND V-35S TUBS)  
Bulk pricing available. Please see our website.

## Snake Discovery – HOW TO SETUP A VISION RACK SYSTEM (STEP BY STEP)



YouTube  
customcages.com/racksetup20

"We have two new racks!! We bought a Vision rack to use as our quarantine rack for new and rescued snakes, and we also got a Vision hatchling rack! In today's video Ted (from Custom Cages) and I show you how to set up their rack systems. At the end we show them all set up and in action with reptiles inside!  
–Emily, Snake Discovery



**RESELLERS & MAINTENANCE SERVICES**

We have a very easy and mutually beneficial reseller program available for you to offer our products to your customers. Our program requires no investment in inventory, heavily discounted in store display unit(s), and delivery to your customers door! Please call or visit [LifetimeAquariums.com](http://LifetimeAquariums.com) or scan QR code in upper right corner to request a packet with more information. Most of our product lines are available through this program for fish aquariums, birds, reptiles, amphibians, cats, dogs, and other small animals.

**ATTENTION CUSTOMERS**

If you would like to see your favorite store or maintenance service company near you offer our products please show them this catalog and ask for us by name! We would love to work with them, and it is super easy! We still offer our high level of support even if you prefer to order locally! Go online to [LifetimeAquariums.com](http://LifetimeAquariums.com) and visit the store locator to find a reseller near you!

**ZOOS – NATURE & HUMANE CENTERS – MUSEUMS**

We have programs available to trade credit towards functional displays in exchange for billboard and online advertising at your facility.



"We were looking for a company to help with our special needs for cages for our zoo and in Custom Cages we found that special company to assist us with all our needs. You give them an idea of your needs and they will deliver. We received more than we were expecting. Their work and service are fantastic. We use them for everything from fish aquariums to a marmoset cage and everything in between. Thank you, Custom Cages!"

—Special Memories Zoo  
Greenville, WI



customcages.com/zoos20

**BRANDING/FUNDRAISING OPPORTUNITIES ALSO AVAILABLE**

We can do large format printing and design—in house—for the background of any of our enclosures. Our graphic designers can work with you to incorporate your sponsors logo into the back of your enclosure. We have many scenic backgrounds to choose from—we can incorporate in the display, as well as custom options by request. We can also work with you to develop promotional materials (such as fundraising flyer handouts) to help promote to earn money to sponsor your facility and your habitat!



customcages.com/advertising20

**ENCLOSURES HAVE BEEN PURCHASED BY:**

Busch Gardens, Tampa, FL, Center for Avian Rehab and Education, Hubertus, WI, Chicago Zoological Society, Brookfield, IL, City of Aurora Zoo, Aurora, IL, Disney's Animal Program, Lake Buena Vista, FL, East Maui Animal Refuge, Haiku, HI, Grant's Farm (Anheuser–Busch), St. Louis, MO, Knoxville Zoo, Knoxville, TN, Lincoln Park Zoo, Chicago, IL, Make–A–Wish Foundation, Nationwide, Mana Project, Key West, FL, Miami Museum of Science & Planetarium, Miami, FL, Michigan State University College of Veterinary Medicine, East Lansing, MI, Milwaukee Zoo, Milwaukee, WI, North Carolina Aquarium, Manteo, NC, Rhode Island Zoological Society, Providence, RI, Ringling Brothers Circus, St. Petersburg, FL, San Diego Wild Animal Park (San Diego Zoo), Escondido, CA, Santa Marie Valley Discovery Museum, Santa Marie, CA, Six Flags Great America, Gurnee, IL, Six Flags Magic Mountain, Valencia, CA, Six Flags Wild Safari Animal Park, Jackson, NJ, Underwater Adventures Aquarium, Bloomington, MN, Virginia Marine Science Museum, Virginia Beach, VA, Wings From Heaven, Homestead, FL, Zoological Society of Florida, Miami, FL... and many, many more!

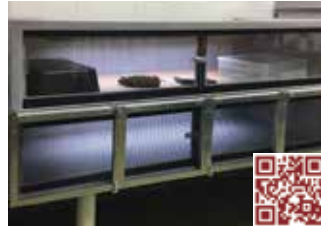

[visionproducts.us/bassproshoptestimonial20](http://visionproducts.us/bassproshoptestimonial20)

### BASS PRO SHOPS— BASE CAMP'S VISION RACKS & CAGES

"We recently upgraded our reptile/snake room and thought you might like to see it and to see that we only use your products. Our recent order via LLL Reptile consisted of the rack system and large V600 cages. Since we house venomous snakes we retrofitted the V600 with a double enclosure front. I think it turned out great and offers extra protection and keeps us within state guidelines."

—Blayk Michaels, Manager of Live Exhibits  
Photos courtesy of **Bass Pro Shops Live Exhibits Dept.**



[customcages.com/reptiletestimonial20](http://customcages.com/reptiletestimonial20)

### SUSAN & LEAH'S SNAKE ENCLOSURE

"Hi Stacy! Well, all we can say is WOW! Leah and I are so very pleased with this terrarium. Ty looks like a baby again in this beautiful enclosure. He has been in it for three days now, and of course we moved as well, so all his views are different. But with a little reassurance and love from us, he has begun to really explore. HE LOVES IT! We put a moon light simulator bulb on at night, and it looks like he's sitting under a full moon. We are so very happy that he gets to enjoy this beautiful tank for the rest of his days. Anyway, we just wanted to say thanks so much for taking such great care of us. I've already had two people ask about his enclosure since posting these pictures, so you might be getting some biz from Georgia. Please tell the owner how much we love this. And thanks again!"

—Susan G\* & Leah D\*



[customcages.com/reptiletestimonial20](http://customcages.com/reptiletestimonial20)

### MONROE'S NEW ENCLOSURE

"Well it's official, she absolutely loves her new home. She has been all over it up and down and hitting each ledge. Her first 4 hours she had a nice soak in her water bowl, and her entire 7 foot body filled it. It's amazing she is SOOO happy, thank you, thank you for all that you did for us here. You guys are fantastic, and seeing Monroe thrive just fills our Hearts." —Chris

Monroe's new enclosure is a 60"L x 60"H x 36"D Hybrid H3 Reptile cage with English Oak finish on the cabinet and hood. The background image is Rocky Forest.



[customcages.com/janetestimonial20](http://customcages.com/janetestimonial20)

### JANET'S CUSTOM CAGES EXPERIENCE

"Custom Cages has been a great company to work with. This was a custom enclosure and they worked with me to get everything exactly as I wanted it.

We spent weeks going back and forth with samples of different woods and finishes and the final product couldn't be better. When you're purchasing something like this, know it will be costly and it takes time to build. I knew from the outset it would be 12 weeks, I placed my order 1/29 and received it 4/19. Paying up-front for a custom piece is customary.

If it's built-for-you then the company would be out if your payment isn't there 3 months later.

When FedEx freight couldn't get the crate off the truck because it was too large, Custom Cages stepped in and had a moving company pick it up and deliver it to me.

I have enjoyed my experience, but I also did my homework and knew what I was getting into. Thanks Stacy and crew for giving my birds the enclosure of my dreams."

—Janet



### BRYAN'S 260-GALLON AFRICAN CICHLID DISPLAY

Bryan's African cichlid display is a [Custom Aquariums](http://CustomAquariums.com) 260-gallon tank with a full Seamless Sump® filtration system.



### CHRIS' PHILIPPINE REEF

Chris took advantage of the [CustomAquariums.com](http://CustomAquariums.com) Organic Advertising Program to purchase his tank, stand, and overflow systems for his reef aquarium.



### SEAN PECK'S SEAMLESS SUMP® FILTER

Sean Peck (PeckTec) chose the [CustomAquariums.com](http://CustomAquariums.com) Seamless Sump® filter system for the largest tank in his home.



### RAY'S 240-GALLON MARINE DISPLAY

Ray has a 240-gallon marine fish display in his home. The set up includes a Lifetime® Aquarium, Majestic® stand and canopy, Seamless Sump® filter system, H2Overflow®, and Siphon Stopper® emitters.



### GORDON'S 300-GALLON CUSTOM AQUARIUMS CICHLID DISPLAY

Gordon operates Bullfrog Spas of Oklahoma City and is an authorized distributor of [CustomAquariums.com](http://CustomAquariums.com) products. We appreciate your business, Gordon!



### DAWN'S 110-GALLON PLANTED AQUARIUM

When Dawn needed to replace her older, worn-out 110-gallon aquarium, she called [Custom Aquariums](http://CustomAquariums.com) for assistance!



### NATE'S 300-GALLON REEF

[Custom Aquariums](http://CustomAquariums.com) cut the glass for Nate's full-length overflow and the glass pieces for his bean-style external overflow box. Nate has previously worked in the commercial aquarium installation and maintenance industry.

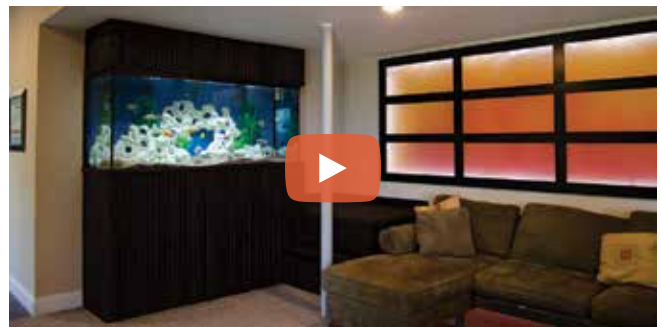

### DAVID, RACHEL & MEGAN'S 240-GALLON AQUARIUM

David and his daughters designed a remodel of their family room to include a large African cichlid aquarium.



YouTube

[customaquariums.com/bettablog20](http://customaquariums.com/bettablog20)

### SIMPLY BETTA—AQUASHELLA—ALL THE BEST PARTS!

"I was at Aquashella and I had such a great time. It was the best show I have ever been to! Yes, I have solo dance parties and I'm not afraid to admit it. Would you consider going to a fish or aquarium show like this one? They had so many things, especially beautiful betta fish!"



YouTube

[customaquariums.com/swiskeyvlog20](http://customaquariums.com/swiskeyvlog20)

### SWHISKEY—THE AQUARIUM'S AT DALLAS AQUASHELLA 2018

"Aquashella!!"



YouTube

[customaquariums.com/tanktestedvlog20](http://customaquariums.com/tanktestedvlog20)

### TANK TESTED—AQUATIC LIZARD—GIANT \$7,000 PALUDARIUM

A giant enclosure for a semi-aquatic caiman lizard.



YouTube

[customaquariums.com/jaywilsonvlog20](http://customaquariums.com/jaywilsonvlog20)

### JAY WILSON—CUSTOM AQUARIUMS EXPOSED!

"In this video we expose *Custom Aquariums* by doing a behind the scenes tour in making aquariums."



## STEVE POLAND AQUATICS

### HOW CUSTOM AQUARIUMS ARE MADE

"I recently announced that I'm working with *Custom Aquariums* on a 300-gallon display tank. In this video, I go to Wisconsin to visit their headquarters to see firsthand how their tanks, stand, and equipment are made."



YouTube

[customaquariums.com/polandhowvlog20](http://customaquariums.com/polandhowvlog20)

### UNBOXING MY 300-GALLON AQUARIUM!

"It's finally here! My 300-gallon tank from *Custom Aquariums* has been delivered. In this video I show the unloading process and give some information about the tank, stand, and sump."



**UNBOXING & SETTING UP 6 TERRARIUMS**

"I'm so excited! My terrarium rack from [Custom Aquariums](#) has finally arrived, and I have all the supplies needed to start setting some of these up as leopard gecko tanks and bioactive dart frog enclosures. Watch as a freight truck delivers three huge crates for me to unbox and load into the fish room and check out the final result of setting up the terrarium rack and the MistKing automatic misting system. Lots of exciting stuff going on!"

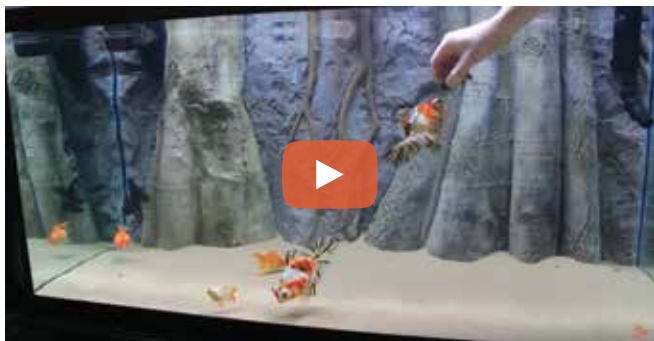

**GOLDFISH AQUARIUM UPGRADE**

"\*crying happy tears\* Something I haven't seen in a while... walking into the fish room and being greeted immediately by my cute goldfish, all swimming back and forth in front of the glass begging for food. I've missed this. Thanks for watching."



**NEW BIOACTIVE DART FROG VIVARIUM!**

"This poison dart frog tank has been such a long time in the making! Watch as I set up my first out of 4 bioactive vivariums for my new reptile and amphibian rack in my fish room. This bioactive vivarium will house my group of 4 *Dendrobates tinctorius* Patricia, along with their insect cleanup crew of isopods and springtails. The vivarium has lots of live plants and plenty of leaf litter hiding places for the frogs."



**HOW FISH TANKS ARE MADE!**

"This was such a cool experience, and I hope you guys enjoy coming along for the ride! I got the full behind-the-scenes tour for you guys including demos showing how the glass aquariums are made here at [Custom Aquariums](#) in Wisconsin. Not only do they make aquariums, but they also make terrariums for reptiles and what they call "amphibious tanks" that can hold water on the bottom. Since I have an assortment of animals in my fish room (not just fish!) [Custom Aquariums](#) will be helping me out with enclosures for all my animals—from goldfish to poison dart frogs to leopard geckos and everything in-between. In this video you'll see my first set of aquariums in production (I even got to help work on them!) and these tanks will be arriving to my fish room sometime this month, so stay tuned to watch me set them up and fill them with beautiful fish!"



**BETH'S HYBRID® BIRD CAGE**—Beth needed a custom bird enclosure for her parrot and conure, she turned to *CustomCages.com*.



**DAVIS' BIOACTIVE BALL PYTHON ENCLOSURE**—Davis has two Hybrid® Reptile enclosures, one of which is a bioactive vivarium for his ball python.



**BRACKETT TOWN FARMS**  
Brackett Town Farms is a special place where people with special needs can go to have peaceful, positive, and enriching interactions with animals.



**KRISTA'S VIVARIUM**  
Krista keeps two female crested geckos in a *Custom Cages* Hybrid® H2 Reptile enclosure set up as a bioactive vivarium.



**TAMARA & JASMINE'S MAJESTIC® ENCLOSURE**  
Tamara purchased a Majestic® reptile enclosure for her boa constrictor, Jasmine.



**DANNY MENDEZ' VISION CAGES—MODEL 222**  
Danny Mendez is a zoologist and animal educator who has been using *Vision Cages* since 1999.



**DENVER ZOO**—“We absolutely love the cage! We love the flexibility to be able to hang up the enrichment and for them to be able to move all the way from top to bottom in their enclosure. So thank you for your great design!”  
—Emily, Animal Ambassador Keeper at Denver Zoo

## TAYLOR NICOLE DEAN



**UPGRADING MY ENTIRE ANIMAL ROOM (CAGE REVEALS PART 1)**  
 "In today's video I tear down my entire animal room and redo it. This was exhausting—I really hope you all enjoy. **THANK YOU TO CUSTOM CAGES FOR THE AMAZING WORK** and brilliant customer service. Please check out their awesome work at [customcages.com](http://customcages.com)."



**HEY MTV WELCOME TO MY LIZARD'S CRIB (HUGE CAGE TOUR)**  
 "Hey MTV, welcome to my roughneck monitor cage. Finishing up the cage rebuild series for Kronos! Also addressing two important subjects: impulse buying and monitor's temperaments. PS, his enclosure DOES have UVB, there's a long strip on top of the cage between the two bulbs in his enclosure."



**SETTING UP MY ANIMAL ROOM (NEW HOUSE TOUR)**  
 "I'm finally back and ready to make some fun new videos."



**DUCK'S FIRST CAGE UPGRADE!! (SHORT TAIL PYTHON CAGE TOUR)**  
 "Upgrading Duck's... aka my Sumatran short tail python's enclosure from her tub that was a part of my rack system, to a *Vision* cage!"

## EMZOTIC



**RESCUED PET SNAKE GETS HIS DREAM HOME (IT'S A PYTHON MANSION!)**  
 "The sweetest rescued pet Burmese Python gets an amazing new enclosure upgrade! This video is made possible thanks to the generosity of [customcages.com](http://customcages.com)."



**LET'S BUILD GRINCHY'S BIRD AVIARY!**  
 "It's finally here! Grinchy's new aviary! Come and check out this epic, **FULLY CUSTOM** aviary build! I want to give a huge shout out to *Custom Cages* for working with me on this project to give my birds this huge upgrade."



**CHUCK HORNE –THE ULTIMATE OUTDOOR LIZARD ENCLOSURES!!!**

"The first video showcasing my new outdoor lizard enclosures for my pair of Honduran Spiny Tail iguanas and a pair of Smallwood's knight anoles! Stay tuned for more videos detailing all aspects of these outdoor enclosures and how it is possible in Virginia! Special thanks to [Customcages.com](http://Customcages.com) for making this possible!!"



**PARROTS R US –WE CHOSE CUSTOMCAGES.COM FOR OUR NEW FLOCK ADDITION & HERE'S WHY!**

"Is this the new baby reveal? ... no... yet perhaps this insight can assist you in making a decision on your next enclosure."



**PATRICK D. NEARY –CUSTOM CAGES FEATURED AT THE CUSTOM AQUARIUMS BOOTH AT AQUASHELLA**

Patrick D. Neary filmed several videos on-site at the Aquashella 2019 fish show in Dallas, which feature Ted Judy from [CustomAquariums.com](http://CustomAquariums.com) and [CustomCages.com](http://CustomCages.com) discussing the quality engineering of our customized enclosures and aquariums.



**SNAKE DISCOVERY –NEW GARTER SNAKE VISION CAGE!**

"In today's video we unbox and setup our very first Vision cage for our garter snakes! Needless to say, they love it!"

# FEATURED ACCESSORIES

[customcages.com/accessories20](http://customcages.com/accessories20)



FEATURED ACCESSORIES



[customcages.com/friendlyfeeder20](http://customcages.com/friendlyfeeder20)

## FRIENDLY FEEDER® SYSTEMS KEY FEATURES:

- Prevents escape while feeding
- External mounting to eliminate waste contamination
- Eliminates cross contamination of food and water
- Easy to clean, dishwasher safe dish
- Durable materials suitable for large destructive birds
- Large enough for macaws and other large birds



[customcages.com/rotatingfeeder20](http://customcages.com/rotatingfeeder20)

## ROTATING FEEDER STATION



[customcages.com/reptilefurniture20](http://customcages.com/reptilefurniture20)

## CAGE REPLICA FURNITURE



[customcages.com/freedom20](http://customcages.com/freedom20)

## FREEDOM CONNECTOR KITS & TUBES

Cat tubes—Easily connect your cage to most windows!  
*Outdoor freedom for indoor pets!*



[customaquariums.com/hopper20](http://customaquariums.com/hopper20)

## UNSTOPPABLE HOPPER®—AQUARIUM FEEDER SYSTEM

**MESS FREE—CLOG FREE—ESCAPE FREE—WORRY FREE**

Stand elevates feeder above the surface so exiting food does not get wet and clog the feeder. Funnel prevents a mess on your lids. Hopper extends pellet food quantity to last over 12 weeks with a well-stocked average tank! *Scan the QR code to watch our video!*



YouTube

## UNSTOPPABLE HOPPER®

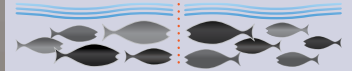

WORRY FREE FISH FEEDER EXTENSION SYSTEM



[customaquariums.com/biomedial20](http://customaquariums.com/biomedial20)

## SEAMLESS SUMP® BIO MEDIA

Our ceramic bio media is just the right shape and size, made from inert material that doesn't alter your water chemistry. Sold in bulk—great value. *Scan the QR above to learn more.*



[customaquariums.com/tubing20](http://customaquariums.com/tubing20)

## TUBING

Our own proprietary Lifetime® pump tubing is translucent green—hides algae but is see through enough to examine the inside. 100% made in USA meaning no guessing the chemical makeup of the vinyl. Tick marks every 2" and 12" make measuring easy. Sold by the foot or bulk in 100' rolls.



[customaquariums.com/substrate20](http://customaquariums.com/substrate20)

## AQUARIUM PLANTS & SUBSTRATES





[customaquariums.com/accessories20](http://customaquariums.com/accessories20)

[customcages.com/birdaccessories20](http://customcages.com/birdaccessories20)



## BIRD

FEATURED ACCESSORIES

BLINDS



BREEDER/NEST BOXES



CASTERS



COCONUT CUPS



LIGHTING



PERCHES



PLAYSTANDS



SWINGS/HANG TOYS



ULTRASONIC MISTER



VENTING



WICKER NESTS



[customcages.com/reptileaccessories20](http://customcages.com/reptileaccessories20)



## REPTILE

ASSORTED PLANTS



HANDLING EQUIPMENT



HEATING



LIGHTING



REPLICA FOOD & WATER DISHES



ROCK LEDGES



SUBSTRATE & DÉCOR



VENTING



[customcages.com/cataccessories20](http://customcages.com/cataccessories20)



## CAT

CATWALKS



CAT SHELVES



CAT TREES



FRIENDLY FEEDER®



HAMMOCKS



ROTATING FEEDERS



[customaquariums.com/fishaccessories20](http://customaquariums.com/fishaccessories20)



## FISH

AIR PUMPS



BACKGROUNDS



BULKHEADS/FITTINGS



CHILLERS



CLEANING SUPPLIES



FILTERS



GLASS HOLE CUTTER KITS



HEATING



LIGHTING



PLANTS/SUBSTRATE



PROTEIN SKIMMERS



UV STERILIZERS



**MANY IMAGE BACKGROUNDS TO CHOOSE FROM! Visit [CustomAquariums.com](http://CustomAquariums.com) & [CustomCages.com](http://CustomCages.com) to see our selection!**

[customcages.com/backgrounds20](http://customcages.com/backgrounds20)

[customaquariums.com/backgrounds20](http://customaquariums.com/backgrounds20)



Hillside Creek



Flooded Forest (2)



Boulder Waterfall



Cypress Forest



Scenic Waterfall



Wooded Steps



Standing Rock



Cascading Falls



Rugged Mountain



Sunken Roots



Red Coral Bloom



Australian Outback



Deep Forest Waterfall



Desert Rock Formations



Flooded Forest



Lily Pad



Sunken Boat



Underwater Forest



Lily Pad Water View